

EN

# SUUNTO STINGER

USER'S GUIDE

  
**SUUNTO**  
REPLACING LUCK.

Present Depth  
 Maximum Depth  
 Average Depth in Logbook  
 Fast Ascent Warning (SLOW)  
 ACW Indicator

Do Not Fly Icon

Arrows:  
 - Decompression Stop at the Ceiling Depth ▼  
 - Mandatory Safety Stop Zone ▲  
 - Ascent Recommended ▲  
 - Must Descend ▼

Bar Graph:  
 - Ascent Rate  
 - Battery Power  
 - Mode Indicator

Diver Attention Symbol

Temperature  
 Maximum Depth  
 Mode Text  
 Oxygen Percentage in Nitrox Mode  
 Week Day  
 Timer Hours and Minutes

Low Battery Warning

Current Time Display  
 No-Decompression Time  
 Surface Interval Time  
 No Flying Time  
 Total Ascent Time  
 Ceiling Depth on Decompression Stop  
 Safety Stop Time  
 Mandatory Safety Stop Depth and Time

Bar Graph:  
 - Mode Indicator  
 - Oxygen Limit Fraction

Altitude Adjustment Mode

Personal Adjustment Mode

AM/PM Indicator

Safety Stop Warning  
 Safety Stop Indicator

Dive Time  
 Dive Counter  
 Oxygen Partial Pressure in Nitrox Mode  
 Time  
 Dual Time  
 Day, Month  
 Timer Seconds  
 Oxygen Partial Pressure

Daily Alarm  
 On Indicator

Dive Alarm  
 On Indicator



## SUUNTO STINGER QUICK REFERENCE GUIDE

## DEFINITION OF WARNINGS, CAUTIONS AND NOTES

Throughout this manual, special references are made when deemed important. Three classifications are used to separate these references by their order of importance.

**WARNING** is used in connection with a procedure or situation that may result in serious injury or death.

**CAUTION** is used in connection with a procedure or situation that will result in damage to the product.

**NOTE** is used to emphasize important information.

## COPYRIGHT, TRADEMARK AND PATENT NOTICE

This instruction manual is copyrighted and all rights are reserved. It may not, in whole or in part, be copied, photocopied, reproduced, translated, or reduced to any media without prior written consent from SUUNTO.

SUUNTO, STINGER, Oxygen Limit Fraction (OLF), SUUNTO Reduced Gradient Bubble Model (RGBM), Continuous Decompression and their logos are all registered or unregistered trademarks of SUUNTO. All rights are reserved.

Patents have been issued or applied for one or several features of this product.

CE

The CE mark is used to mark conformity with the European Union EMC directive 89/336/EEC. The SUUNTO dive instruments fulfill all the required EU directives.

FIOH, Laajaniityntie 1, FIN-01620 Vantaa, Finland, notified body no.0430, has EC type-examined this type of personal protective equipment.

This instrument must be serviced by an authorized dealer every second year or after 500 dives (whichever comes first). See chapter 6.

PrEN 13319

PrEN 13319 "Diving accessories - Depth gauges and combined depth and time measuring devices - Functional and safety requirements, test methods" is a European diving depth gauge standard draft. The STINGER is designed to comply with this draft standard.

ISO 9001

SUUNTO Oy's Quality Assurance System is certified by Det Norske Veritas to be according to the ISO 9001 in all SUUNTO Oy's operations (Quality Certificate No. 96-HEL-AQ-220).

SUUNTO Oy does not assume any responsibility for losses or claims by third parties, which may arise through the use of this device.

Due to continuous product development, the STINGER is subject to change without notice.

## **WARNING**

Read this manual. Carefully read this instruction manual in its entirety paying close attention to all warnings listed below, including chapter 1.1. "Safety Precautions". Make sure that you fully understand the use, displays and limitations of the dive computer because any confusion resulting from neglecting to follow this instruction manual or from improper use of this device may cause a diver to commit errors that may lead to serious injury or death.

## **WARNING**

Not for professional use. Suunto dive computers are intended for recreational use only. The demands of commercial or professional diving may expose the diver to depths and exposures that tend to increase the risk of decompression illness (DCI). Therefore, Suunto strongly recommends that the device be not used for commercial or professional diving activity.

## **WARNING**

Only divers trained in the proper use of scuba diving equipment should use a dive computer. No dive computer can replace the need for proper dive training. Insufficient or improper training may cause diver to commit errors that may lead to serious injury or death.

## **WARNING**

There is always a risk of decompression illness (dci) for any dive profile even if you follow the dive plan prescribed by dive tables or a dive computer. no procedure, dive computer or dive table will prevent the possibility of dci or oxygen toxicity. An individual's physiological make up can vary from day to day. The dive computer cannot account for these variations. You are strongly advised to remain well within the exposure limits provided by the instrument to minimize the risk of DCI. As an added measure of safety, you should consult a physician regarding your fitness before diving.

## **WARNING**

Suunto strongly recommends that sport divers limit their maximum depth to 40 m [130 ft] or to the depth calculated by the computer based on the selected O<sub>2</sub>% and a maximum PO<sub>2</sub> of 1.4 bar settings.

## **WARNING**

Dives with required decompression stops are not recommended. you should ascend and begin decompression immediately when the dive computer shows you that a decompression stop is required. Note the blinking ASC TIME symbol and the upward pointing arrow.

## **WARNING**

Use back-up instruments. Make sure that you use back-up instrumentation including a depth gauge, submersible pressure gauge, timer or watch, and have access to decompression tables whenever diving with a dive computer.

## **WARNING**

Perform prechecks. Always activate and check the device before diving in order to ensure that all Liquid Crystal Display (LCD) segments are completely displayed, that the device has not run out of battery power, and that the oxygen, altitude and personal adjustments are correct. Also, exit the Data Transfer mode before diving, as the computer does not automatically revert to Dive mode from Data Transfer mode.

## **WARNING**

You are advised not to fly any time the computer counts down the no-flying time. always activate the computer to check the remaining no-fly time prior to flying. The computer goes into the stand-by display automatically 5 minutes after surfacing. Flying or traveling to a higher altitude within no-fly time can greatly increase the risk of DCI. Review the recommendations given by Diver's Alert Network (DAN) in chapter 3.2.3.4. "Flying After Diving". There can never be a flying after diving rule that is guaranteed to completely prevent decompression illness!

## **WARNING**

The dive computer should never be traded or shared between users while it is in operation. Its information will not apply to someone who has not been wearing it throughout a dive or sequence of repetitive dives. Its dive profiles must match that of the user. If it is left on the surface during any dive, it will give inaccurate information for subsequent dives. No dive computer can take into account dives made without the computer. Thus any diving activity up to four days prior to initial use of the computer may cause misleading information and must be avoided.

## **WARNING**

Do not dive with a cylinder of enriched air if you have not personally verified its contents and entered the analyzed value into your dive computer. Failure to verify cylinder contents and enter the appropriate O<sub>2</sub>% into your dive computer will result in incorrect dive planning information.

## **WARNING**

The dive computer will not accept fractional percentage values of oxygen concentration. do not round up fractional percentages. For example, 31.8% oxygen should be entered as 31%. Rounding up will cause nitrogen percentages to be understated and will affect decompression calculations. If there is a desire to adjust the computer to provide more conservative calculations, use the personal adjustment feature to affect decompression calculations or reduce the PO<sub>2</sub> setting to affect oxygen exposure.

## **WARNING**

Set the correct Altitude Adjustment Mode when diving at altitudes greater than 300 m [1000 ft] the Altitude Adjustment feature must be correctly selected in order for the computer to calculate the decompression status. The dive computer is not intended for use at altitudes greater than 3000 m [10000 ft]. Failure to select the correct Altitude Adjustment setting or diving above the maximum altitude limit will result in erroneous dive and planning data.



## **WARNING**

Set the correct Personal Adjustment Mode. Whenever it is believed that factors that tend to increase the possibility of DCI exist, it is recommended that you use this option to make the calculations more conservative. Failure to select the correct Personal Adjustment Setting will result in erroneous dive and planning data.

## **WARNING**

Freediving after scuba diving is not recommended. It is recommended to avoid freediving for at least two hours and not to exceed five meters [16 ft] after scuba diving depending on your diving activity. Suunto also recommends you to be trained in freediving technique and physiology before conducting breath holding dives. No dive computer can replace the need for proper dive training. Insufficient or improper training may cause diver to commit errors that may lead to serious injury or death.

## **NOTE:**

Free mode automatically changes to Gauge mode when the dive time exceeds five minutes for a single dive. If the Stinger is in Gauge mode it is not possible to set it to Air or EAN modes until 48 hours have passed. This does not apply to changing between Free and Air or EAN modes.

Changing from Air to EAN mode is possible at any time. Changing from EAN to Air mode however requires you to wait until the no-flying time has counted down.

# TABLE OF CONTENTS

1. INTRODUCTION .....	12
1.1. SAFETY PRECAUTIONS .....	13
1.1.1. Emergency Ascents .....	14
1.1.2. Dive Computer Limitations .....	14
1.1.3. Nitrox .....	15
1.1.4. Freediving .....	15
2. GETTING ACQUAINTED .....	17
2.1. FUNCTIONS .....	17
2.2. PUSH BUTTONS .....	17
2.3. WATER CONTACTS .....	18
2.4. TIME MODE [TIME] .....	19
2.4.1. Timekeeping Display .....	20
2.4.2. Stopwatch [Timer] .....	21
3. DIVING WITH THE STINGER .....	23
3.1 BEFORE DIVING .....	24
3.1.1. Activation and Prechecks .....	24
3.1.2. Battery Power Indicator and Low Battery Warning .....	26
3.1.3. User Definable Functions and Alarms .....	28
3.1.3.1. Presetting Time Alarm .....	29
3.1.3.2. Presetting Dive Alarms .....	29
3.1.4. Bookmark .....	29

3.2. SCUBA DIVING .....	30
3.2.1. Diving with Air .....	30
3.2.1.1. Dive Planning [PLAN] .....	30
3.2.1.2. Presetting the Displays in the Air mode .....	32
3.2.1.3. Basic Dive Data .....	32
3.2.1.4. Safety stops .....	34
3.2.1.4.1. Recommended Safety Stop .....	35
3.2.1.4.2. Mandatory Safety Stop .....	35
3.2.1.5. Ascent Rate Indicator .....	37
3.2.1.6. Decompression dives .....	39
3.2.2. Diving with EAN (Nitrox) .....	45
3.2.2.1. Before Diving .....	45
3.2.2.2. Presetting the Displays in the EAN mode .....	46
3.2.2.3. Oxygen Displays .....	47
3.2.2.4. Oxygen Limit Fraction (OLF) .....	48
3.2.3. At the Surface .....	49
3.2.3.1. Surface Interval after an Air/EAN Dive .....	49
3.2.3.2. Diver Attention Symbol .....	51
3.2.3.3. Dive Numbering .....	51
3.2.3.4. Flying After Diving .....	52
3.2.4. High Altitude Dives and Personal Adjustment .....	53
3.2.4.1. Altitude Adjustment .....	53
3.2.4.2. Personal Adjustment .....	55
3.2.5. Error Conditions .....	57

3.3. FREE / GAUGE MODE .....	58
3.3.1. Before Diving in the Free/Gauge mode .....	58
3.3.2. Presetting the Displays in the Free/Gauge mode .....	60
3.3.3. Freediving .....	60
3.3.3.1. Freediving Day History .....	61
3.3.4. Gauge mode .....	62
3.3.5. Surface Interval After a Free/Gauge Dive .....	63
3.4. AUDIBLE AND VISUAL ALARMS .....	65
4. SETTING MODE [SET] .....	68
4.1. SETTING TIME, DATE AND DUAL TIME [TIME ] .....	68
4.2. DAILY ALARM SETTING [ALM] .....	70
4.3. AIR AND ENRICHED AIR NITROX SETTINGS [EAN] .....	72
4.4. FREEDIVING AND GAUGE SETTINGS [FREE] .....	74
4.5. DIVE ALARM SETTINGS [DIVE AL] .....	75
4.6. ALTITUDE, PERSONAL AND UNIT ADJUSTMENT SETTINGS .....	
[Adj] .....	77
5. MEMORIES AND DATA TRANSFER [MEM] .....	79
5.1. LOGBOOK AND DIVE PROFILE MEMORY [LOG] .....	80
5.2. DIVE HISTORY MEMORY [HIS] .....	85
5.3. DATA TRANSFER AND PC-INTERFACE [TR-PC] .....	86
6. CARE AND MAINTENANCE .....	89
6.1. CARE OF YOUR STINGER .....	89
6.2. MAINTENANCE .....	91
6.3. WATER RESISTANCE INSPECTION .....	92

7. TECHNICAL DESCRIPTION .....	93
7.1. OPERATING PRINCIPLES .....	93
7.2. REDUCED GRADIENT BUBBLE MODEL, SUUNTO RGBM .....	96
7.3. OXYGEN EXPOSURE .....	98
7.4. TECHNICAL SPECIFICATION .....	100
8. WARRANTY .....	105
9. GLOSSARY .....	107

# 1. INTRODUCTION

Congratulations on your purchase of the SUUNTO STINGER advanced dive computer. The Stinger builds on the Suunto tradition of delivering feature-rich dive computers. The Stinger provides many new and enhanced features that cannot be found in any other dive computer. Push button controls access a wide selection of choices. The display is optimized for the dive mode chosen and it incorporates the patented user definable display field. This dive computer is a compact and sophisticated multipurpose dive instrument, designed to give you years of trouble-free service.

## CHOICE OF DIVING AND WATCH MODES

User options for the Stinger are selected using the push buttons. Pre dive configuration and setup options include:

- Choice of operating mode - Air / Nitrox / Free/Gauge
- Maximum depth alarm
- Dive time alarm
- Mix Oxygen fraction % (Nitrox mode only)
- Oxygen partial pressure alarm limit
- Altitude adjustment
- Personal adjustment
- Choice of unit - Metric / Imperial
- Clock, calendar, daily alarm, stopwatch, dual time
- User definable display fields

## CONTINUOUS DECOMPRESSION WITH SUUNTO RGBM

The Suunto Reduced Gradient Bubble Model (RGBM) utilized in the Stinger predicts both dissolved and free gas in blood and tissues of divers. It is a significant advance on the classic Haldane models, which do not predict free gas. The advantage of Suunto RGBM is additional safety through its ability to adapt to a variety of situations and dive profiles.

In order to optimize how to respond to different added risk situations an additional category of stop, referred to as a Mandatory Safety Stop, has been introduced. Also a countdown for the Recommended Safety Stop is included. The combination of stop types will depend on the specific dive situation.

To get the most from the safety benefits be sure to read the summary of the Suunto Reduced Gradient Bubble Model in chapter 7.2.

### **1.1. SAFETY PRECAUTIONS**

Do not attempt to use Stinger without reading this instruction manual in its entirety, including all the warnings. Make sure that you fully understand the use, displays and limitations of the instrument. If you have any questions about the manual or the dive computer, contact your SUUNTO dealer before diving with the dive computer.

Always remember that you are responsible for your own safety.

When used properly, the dive computer is an outstanding tool for assisting properly trained, certified divers in planning and executing sport dives. It is not a substitute for certified scuba instruction, including training in the principles of decompression.

Diving with enriched air mixtures (nitrox) exposes the user to risks different from those associated with diving with standard air. These risks are not obvious and require training to understand and avoid. Risks include possible serious injury or death.

Do not attempt to dive with any gas mix other than standard air without first receiving certified training in this specialty.

### **1.1.1. EMERGENCY ASCENTS**

In the unlikely event that Stinger malfunctions during a dive, follow the emergency procedures provided by your certified dive training agency or, alternatively,

STEP 1: Assess the situation calmly and then move promptly to less than 18 m [60 ft].

STEP 2: At 18 m [60 ft], slow down your ascent rate to 10 m/min [33 ft/min] and move to a depth between 3 and 6 meters [10 to 20 ft].

STEP 3: Stay there as long as you assess your air supply will safely allow. After reaching the surface stay out of the water for at least 24 hours.

### **1.1.2. DIVE COMPUTER LIMITATIONS**

While the dive computer is based on current decompression research and technology, you must realize that the computer cannot monitor the actual physiological functions of an individual diver. All decompression schedules currently known to the authors, including the U.S. Navy Tables, are based on theoretical mathematical models, which are intended to serve as a guide to reduce the probability of decompression illness.



### **1.1.3. NITROX**

Diving with nitrox provides the diver with an opportunity to reduce the risk of decompression illness by reducing the nitrogen content in the breathing gas mix.

However, when the gas mix is altered, the oxygen content of the mix is generally increased. This increase exposes the diver to an oxygen toxicity risk not usually considered in recreational diving. In order to manage this risk, the dive computer tracks the time and intensity of the oxygen exposure and provides the diver with information to adjust the dive plan in order to maintain oxygen exposure within reasonably safe limits.

In addition to the physiological effects of enriched air on the body there are operational considerations to be addressed when handling altered breathing mixes. Elevated concentrations of oxygen present a fire or explosion hazard. Consult with the manufacturer of your equipment about its compatibility with nitrox.

### **1.1.4. FREEDIVING**

Freediving, and particularly freediving in combination with scuba diving, may have risks that have not been researched and are not commonly known.

Any person who engages in any form of breathhold diving is in danger of shallow-water blackout (SWB) i.e. the sudden loss of consciousness caused by oxygen starvation.

Any breathhold diving results in some nitrogen build-up in the blood and other fast tissues. Due to the short time spent at depth this build-up is generally not significant.

Therefore, provided the effort involved in freediving has not been severe, there is little risk in diving after breathhold diving. However, the converse is more unknown and may increase significantly the risk of DCI. Therefore, **FREEDIVING AFTER SCUBA DIVING IS NOT RECOMMENDED**. You should avoid freediving and not exceed five meters [16 ft] for at least two hours after scuba diving.

Suunto also recommends you to be trained in freediving technique and physiology before conducting breathhold dives. No dive computer can replace the need for proper dive training. Insufficient or improper training may cause a diver to commit errors that may lead to serious injury or death.

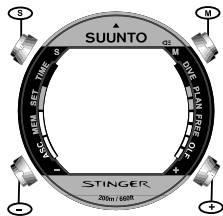

Fig. 2.1. The push buttons of the Stinger.

## **2. GETTING ACQUAINTED**

### **2.1. FUNCTIONS**

The STINGER Advanced Computer Watch is a multipurpose dive instrument and a sport watch featuring several watch and dive computer modes. You can select the dive computer model between the Regular Air Dive Computer (AIR), Enriched Air Nitrox Dive Computer (EAN) and Freediving computer / Depth Gauge with Timer mode (FREE). The Air/EAN and Free modes can also be disabled (set to OFF) and the instrument can be used as a sports watch on land or in water.

### **2.2. PUSH BUTTONS**

The Stinger is controlled with four push buttons as follows (see Fig. 2.1.).

#### **M (MODE)**

- To change from a main mode to an other main mode press the mode button.
- To exit from a submode to a main mode press the mode button.
- To activate the electroluminescent backlight hold down the mode button for more than two seconds or one second in the diving mode.
- To accept the settings in the Setting Mode press the mode button.

#### **S (SELECT)**

- To select a submode press the select button.
- To select the active segment in the Setting Mode press the select button.

- To select the display in the Logbook Mode press the select button.
- To select the dive planning mode in the dive surface modes.
- To make a special bookmark in the profile memory during a dive and to operate the timer in the Gauge mode.

#### +,-

- To show the date, seconds or dual time in the time keeping display press the + or - button.
- In the Setting Mode
  - to increase the value press the + button
  - to decrease the value press the - button.
- To operate the stopwatch see chapter 2.4.2.
- To select the dive in the Logbook Mode
  - press the + button to move forward
  - press the - button to move backwards.

## **2.3. WATER CONTACTS**

The water contact is located on the right side of the case (Fig. 2.2.). When submerged the contact is connected to the case by the conductivity of the water and the Surface or Diving Mode is automatically activated.

Contamination or dirt on the water contact may prevent this automatic operation. It is, therefore, important that the water contact is kept clean. The contact can be cleaned with fresh water and a soft brush (e.g. tooth brush).

**NOTE:** Water or moisture build-up around the water contact may cause the contact to activate automatically. This can happen, e.g., when washing your hands or sweating. If the water contact activates in the Time Mode, an ACW text will appear on display (Fig. 2.3.), and it will be shown until the water contact deactivates, or the Stinger enters the Dive Mode automatically. To save the battery power, you should deactivate the water contact by cleaning it and/or drying it with a soft towel.

## 2.4. TIME MODE [TIME]

The Stinger has dual time, calendar clock, stopwatch and alarm clock functions. The calendar clock and the stopwatch are operated in the Time Mode. The mode is indicated by the TIME text and the mode indicator in the display (Fig. 2.4.). The time, dual time, date and the daily alarm are set in the Setting Mode (see chapter 4).



Fig. 2.2. The water contact and depth sensor.



Fig. 2.3. Active water contact is indicated by the text ACW.



Fig. 2.4. The Time Mode is indicated by the TIME text and a mode indicator.

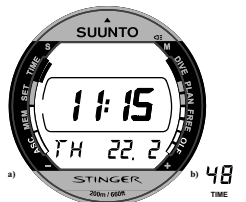

Fig. 2.5. The time keeping display  
 a) the date is displayed  
 b) the seconds are displayed  
 c) the dual time is displayed.

## 2.4.1. TIMEKEEPING DISPLAY

The timekeeping display is the primary display of the Stinger (Fig. 2.5.). When the Time Mode is entered from other modes, the timekeeping display activates within two seconds, if no button is operated.

In other modes (except in the Diving or Stopwatch Modes), if no button is operated within 5 minutes, the Stinger beeps and returns to the timekeeping display automatically.

Either the date (a), the seconds of the current time (b) or dual time (c) are shown on the bottom line of the timekeeping display. Press the + or - button to select the desired display option. Next time when you enter the timekeeping display, the Stinger will show the selected option. The TIMER text blinks on the display if the stopwatch is running.

The display is illuminated by holding down the **M** button for more than two seconds.

To set the time and date, refer to chapter 4.1 "Setting Time, Date and Dual Time".

When diving, the dive entry time and date is registered in the Logbook Memory. Remember always to check before diving that the time and date are correctly set, especially when traveling to different time zones.

### 2.4.2. STOPWATCH [TIMER]

The Stopwatch function is entered by pressing the S button, when the time keeping display is shown. The text **TIMER** at the bottom and the mode indicator (TIME) on the left side of the display indicate that you have entered the Stopwatch function (Fig. 2.6).

The stopwatch of the Stinger lets you measure elapsed time, split times and the times of two runners. The range of the stopwatch is 9 hours, 59 minutes, 59.9 seconds (Fig. 2.7.). When the range is exceeded the computer watch gives a beep and returns to the time keeping display automatically.



Fig. 2.6. The Stopwatch function is indicated by the **TIMER** text and a mode indicator.



Fig. 2.7. The Stopwatch displays hours, minutes and seconds.

Use the + and - buttons to operate the elapsed time measurement, split time measurement or the times of two runners as follows:

***Elapsed time measurement***



***Split time measurement***



***Times of two runners***

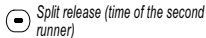
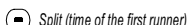

Diving with the Stinger or data transfer will stop the stopwatch. However, it is possible to use stopwatch function when diving, if the Air/EAN and Free -diving modes are disabled (set to OFF, see chapter 3.2.). There is also a separate stopwatch (dive timer) that can be used when diving in the Free/Gauge mode (see chapter 3.3.).



### 3. DIVING WITH THE STINGER

In order to familiarize yourself with the menu based functions, Suunto recommends you use your Quick Reference Guide supplied with the Stinger together with the information in the following chapters.

This section contains instructions on how to operate the dive computer and interpret its displays. You will find that this dive computer is easy to use and read. Each display shows only the data relevant to that specific diving situation.

Chapter 3.1. Before Diving contains general instructions for all the dive computer modes. Chapter 3.2. Scuba Diving information for air and enriched air nitrox scuba diving and Chapter 3.3. Free / Gauge Mode information for freediving or diving in the gauge mode.

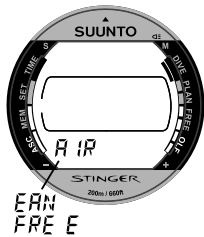
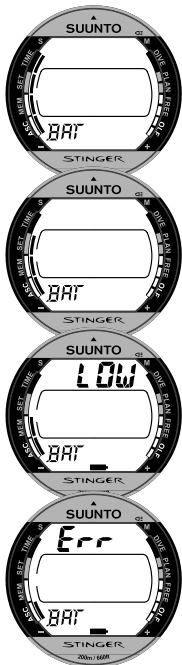

Fig. 3.1. Chosen Dive Mode.



Fig. 3.2. Startup I. All segments shown.



## a) 3.1 BEFORE DIVING

### 3.1.1. ACTIVATION AND PRECHECKS

The instrument can be activated by pressing the M button or it will activate the scuba dive computer mode (default) or freedive mode according the user selection, if submerged deeper than 0.5 m (1.5 ft).

The chosen Dive Mode is indicated by the Air, EAN or Free texts and mode indicator on the right side of the display (Fig. 3.1.). Next, all display elements will turn on showing mostly figure 8's and graphical elements (Fig. 3.2.). A few seconds later the battery power indicator is shown and the backlight and the buzzer are activated (Fig. 3.3a.). Next, the screen will display the mode dependent Ready display confirming that the activation is complete (Fig. 3.4.).

At this time, perform your precheck making sure that:

- d)
- the Stinger operates and provides a complete display
  - the low battery indicator is not on
  - the instrument displays correct units

Fig. 3.3. Startup II. Battery power indicator.

- the instrument displays correct temperature and depth (0.0 m [0 ft])
- the buzzer beeps
- you have preset desired displays on the User Definable Display Field
- the altitude and personal adjustment settings are correct (Air and EAN modes)

And if set to EAN mode, make sure that:

- the oxygen percentage is adjusted according to the measured Nitrox blend in your cylinder
- the oxygen partial pressure limit is set correctly.

The Stinger is now ready for diving.

**NOTE:** The surface interval time does not run before the first dive.

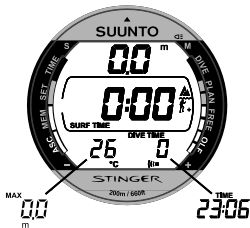

Fig. 3.4. Startup III. Surface mode (Air). Depth and dive time are zero. Pressing +/- button activates alternative display of maximum depth and current time.

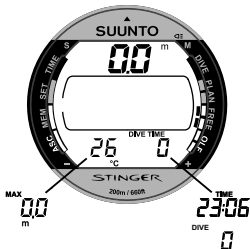

Fig. 3.5. Startup IV. Free/Gauge mode. Depth and dive time are zero. Pressing +/- button activates alternative display of maximum depth and current time or dive number.

After activation of the Dive Mode or after diving, the Stinger will automatically switch to show the time keeping display within 5 minutes to conserve the battery power, if you do not press any buttons. However, the dive computer functions will remain active until it has calculated that all residual nitrogen has off-gassed. This may take up to 100 hours, as described in chapter 7.1. "Operating Principles". However, SUUNTO recommends to turn on the Dive Mode before diving to check the settings, battery warning, etc. and for dive planning.

### **3.1.2. BATTERY POWER INDICATOR AND LOW BATTERY WARNING**

This dive computer has a unique graphic Battery Power Indicator designed to give you an advance notice of impending need to change the battery.

The Battery Power Indicator can always be seen as the Dive Mode is activated. The electroluminescent backlight will be on during the battery check. The following Table and Figure show the various warning levels.

TABLE 3.1. BATTERY POWER INDICATOR

Display	Operation	Figure 3.3
BAT + 4 segments	Normal, full battery.	a)
BAT + 3 segments	Normal, battery power is getting low or the temperature is low. Battery replacement is recommended if you are going to colder conditions or if you are planning to make a dive trip.	b)
BAT + LOW + 2 segments + low battery symbol	Battery power is low and the battery replacement is recommended. The battery symbol is displayed. The backlight is disabled.	c)
BAT + ERR 1 segment + low battery symbol	Change the battery! Returns to the Time display. Activation and all functions are disabled.	d)

Temperature or an internal oxidation of the battery affects the battery voltage. If the instrument is stored for a long period, the low battery warning may be displayed even though the battery has enough capacity. The low battery warning may also be displayed at low temperatures, even though the battery has enough capacity in warmer conditions. In these cases repeat the battery check procedure.



Fig. 3.6. Low Battery Warning. Battery symbol indicates that the battery is low and battery replacement is recommended.



Fig. 3.7. Bookmark activation. An annotation, Bookmark, is placed in the profile memory during a dive by pressing the S button (Displayed with Diver Attention symbol.).

After the battery check the Low Battery Warning is indicated by the battery symbol (Fig. 3.6.).

If the battery symbol is displayed in the Surface mode or if the display is faded or weak, the battery may be too low to operate the dive computer and battery replacement is recommended.

**NOTE:** For safety reasons the backlight cannot be activated when the low battery warning is indicated by the battery symbol.

### 3.1.3. USER DEFINABLE FUNCTIONS AND ALARMS

This Stinger has several User Definable Functions and depth and time related alarms that you can set according to your personal preference. For example the Stinger has a patented presetting system for the User Definable Display Field in the lower part of the display.

The displays can be preset in the Surface Mode. If it is not active, enter it by selecting the Dive Mode. The preset display will remain active until another display is selected. The preset displays will be the default displays in the Diving Mode. The other available display can be accessed by pressing the + or - button. After five seconds the display changes back to the default preset display automatically.

### **3.1.3.1. PRESETTING TIME ALARM**

The alarm clock is set in the Setting Mode, ALM. For further information see chapter 4.2.

### **3.1.3.2. PRESETTING DIVE ALARMS**

The dive alarms (dive time alarm and maximum depth alarm) are set in the Setting Mode, DIVE AL. For further information see chapter 4.5.

### **3.1.4. BOOKMARK**

It is possible to make special marks in the profile memory during a dive. These Bookmarks will be shown as a Diver Attention Symbol when scrolling the profile memory on the computer display (Fig. 3.7). The Bookmarks will also be shown as annotations in the PC-software, Suunto Dive Manager. To make a bookmark on the profile memory during a dive press the **S** button. The Diver Attention Symbol will be displayed to confirm the bookmark. In the Gauge mode pressing the **S** button also resets the stopwatch.

## 3.2. SCUBA DIVING

### 3.2.1. DIVING WITH AIR

#### 3.2.1.1. DIVE PLANNING [PLAN]

It is possible at any time in the Air/EAN Surface Mode to enter the Planning Mode, simply by pressing the **S** button. After showing the text PLAN and the mode indicator (Fig. 3.8.), the display will show the no-decompression limit for the depth of 9 m [30 ft]. By pressing the + button, the Stinger will calculate and show the next deeper no-decompression limits in 3 m [10 ft] increments ending at 45 m [150 ft] or at the maximum allowed depth in the EAN mode. By pressing the - button the next shallower depth will be shown again.

The Planning Mode can be canceled by pressing the **M** or the **S** button.

**NOTE:** The Planning mode is disabled in the Air/EAN Error mode (see chapter 3.2.5.).

Higher Altitude and conservative Personal Adjustment Modes will shorten the no-decompression time limits. These limits at different Altitude and Personal Adjustment Mode selections are shown in Table 7.1. and 7.2.



The Planning mode also accounts for the following information from previous dives:

- any calculated residual nitrogen
- all dive history for the past four days
- oxygen exposure (EAN mode)

The no-decompression times given for different depths will therefore be shorter than before your first "fresh" dive.

## DIVE NUMBERING SHOWN DURING DIVE PLANNING

Dives belong to the same repetitive dive series if the instrument was still counting down the no-fly time at the beginning of the dive.

The surface interval must be at least 5 minutes for a dive to be considered a repetitive dive. Otherwise, it is considered a continuation of the same dive. The dive number will not change and the dive time will continue where it left off (see chapter 3.2.3.3.).



Fig. 3.8. Dive Planning. The Planning mode is indicated by the PLAN text and mode indicators.



Fig. 3.9. Planning. The no-decompression time limit at 30.0 m [100 ft] is 18 minutes in P0/A0 mode.

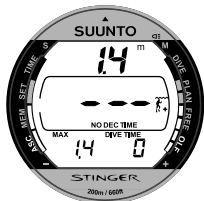

Fig. 3.10. Dive has just begun. Available no-decompression time is more than 199 min.

### 3.2.1.2. PRESETTING THE DISPLAYS IN THE AIR MODE

Preset with the - button in the lower left corner of the display (Fig. 3.4.):

- the maximum depth or
- the temperature.

Preset with the + button in the lower right corner of the display (Fig. 3.4.):

- the dive time or
- the current time.



Fig. 3.11. Diving display. Present depth is 19.3 m [63 ft] and no-decompression stop time limit is 23 minutes in A0/P1 mode. Maximum depth during this dive has been 19.8 m [65 ft], elapsed dive time is 16 minutes. Alternative display shows temperature and current time.

### 3.2.1.3. BASIC DIVE DATA

The dive computer will remain in the Surface mode at depths less than 1.2 m [4 feet]. At depths greater than 1.2 m the instrument will go into the Diving mode (Fig. 3.10.).

During a no-decompression stop dive, the following information will be displayed (Fig. 3.11.):

- your present depth in meters [ft]
- the Altitude Adjustment setting on the right side of the center window with a wave and mountain symbols (A0, A1, or A2) (see Table 3.3.)
- the Personal Adjustment setting on the right side of the center window with a diver symbol and + signs (P0, P1, or P2) (see Table 3.4.)
- the available no-decompression time in minutes in the center window as NO DEC TIME. It is calculated based on the five factors described in chapter 7.1. "Operating Principles".
- the maximum depth during this dive in meters [ft], indicated as MAX or the temperature in °C [°F] in the lower left corner.
- the elapsed dive time in minutes, indicated as DIVE TIME or the current time, indicated as TIME in the lower right corner.

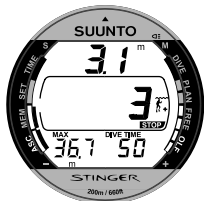

Fig. 3.12. A three minute Recommended Safety Stop.



Fig. 3.13. Mandatory Safety Stop. You are advised to make a mandatory Safety Stop in the zone between the ceiling and floor.

### 3.2.1.4. SAFETY STOPS

Safety stops are widely considered "good diving practice" and are an integral part of most dive tables. Reasons to perform a safety stop include a reduction in sub clinical DCI, microbubble reduction, ascent control, and orientation before surfacing.

The Stinger displays two different types of safety stops: Recommended Safety Stop and Mandatory Safety Stop.

The Safety Stops are indicated by:

- STOP label, when in the depth range 3 m - 6 m [10 ft - 20 ft] = Recommended Safety Stop Countdown which is activated when the depth of 10 m [30 ft] is exceeded.
- STOP+ CEILING label, when in the depth range 3 m - 6 m [10 ft - 20 ft] = Mandatory Safety Stop Time display
- STOP label, when deeper than 6 m = Mandatory Safety Stop scheduled

### **3.2.1.4.1. RECOMMENDED SAFETY STOP**

With every dive over 10 meters the instrument has a three minute countdown for the recommended safety stop, to be taken in the 3 - 6 meter [10 ft - 20 ft] range. This is shown with the STOP sign and a three-minute countdown in the center window instead of the no-decompression time (Fig. 3.12.).

The Recommended Safety Stop, as the name implies, is recommended. If it is ignored, there is no penalty applied to the following surface intervals and dives.

### **3.2.1.4.2. MANDATORY SAFETY STOP**

When the ascent rate exceeds 12 meters/min [40 ft] momentarily or 10 meters/min [33ft] continuously the micro-bubble build-up is predicted to be more than allowed for in the decompression model. The Suunto RGBM calculation model responds to this by adding a Mandatory Safety Stop to the dive. The time of this Mandatory Safety Stop will depend on the severity of the ascent rate excess.

The STOP sign will appear in the display and when you reach the depth zone between 6 m to 3 m [20 ft to 10] also the CEILING label, ceiling depth and the calculated Safety Stop time appear in the display. You should wait until the Mandatory Safety Stop warning disappears (Fig. 3.13.).

The Mandatory Safety Stop time always includes the three minute Recommended Safety Stop time. The total length of the Mandatory Safety Stop time depends on the seriousness of the ascent rate violation.



Fig. 3.14. Violated Mandatory Safety Stop. Downward pointing arrow and an audible alarm indicate you should descend to ceiling zone.

You must not ascend shallower than 3 m [10 ft] with the Mandatory Safety Stop warning on. If you ascend above the Mandatory Safety Stop ceiling, a downward pointing arrow will appear and a continuous beeping starts (Fig. 3.14.). You should immediately descend to, or below, the Mandatory Safety Stop ceiling depth. If you correct this situation at any time during that dive, there are no effects on the decompression calculations for future dives.

If you continue to violate the Mandatory Safety Stop, the tissue calculation model is affected and the dive computer shortens the available no-decompression time for your next dive. In this situation, it is recommended to prolong your surface interval time before your next dive.

### 3.2.1.5. ASCENT RATE INDICATOR

The ascent rate is shown graphically along the left side of the display as follows:

TABLE 3.2. ASCENT RATE INDICATOR

<b>Ascent Rate Indicator</b>	<b>The equivalent ascent speed</b>	<b>Example in Fig.</b>
No segments	Below 4 m/min [13 ft/min]	3.10
One segment	4 - 6 m/min [13 - 20 ft/min]	3.11
Two segments	6 - 8 m/min [20 - 26 ft/min]	3.12
Three segments	8 - 10 m/min [26 - 33 ft/min]	3.13
Four segments	10 - 12 m/min [33 - 39 ft/min]	3.14
Four segments, the SLOW segment, blinking depth reading, the STOP sign and an audible alarm	Above 12 m/min [39 ft/min] or continuously above 10 m/min [33 ft/min]	3.15

When the maximum allowed ascent rate is exceeded, the SLOW warning and the STOP sign appear, indicating that the maximum ascent rate has been exceeded continuously or that the current ascent rate is significantly above the allowed rate.



Fig. 3.15 Ascent Rate Indicator. Blinking SLOW and four segments are shown together with an audible alarm: ascent rate is more than 10 m/min [33 ft/min]. This is a caution to slow down! STOP sign means that you are advised to make a Mandatory Safety Stop when you reach a depth of 6 m [20 ft].

Whenever the SLOW warning segment and the STOP sign appear (Fig. 3.15.), you should immediately slow down your ascent. When you reach the depth zone between 6 m to 3 m [20 ft to 10 ft] the STOP and CEILING depth labels will advise you to make a Mandatory Safety Stop. Wait until the warning disappears (Fig. 3.13.). You should not ascend shallower than 3 m [10 ft] with the Mandatory Safety Stop warning on.

## WARNING

Do not exceed the maximum ascent rate! Rapid ascents increase the risk of injury. You should always make the Mandatory and Recommended Safety Stops after you have exceeded the maximum recommended ascent rate. If this Mandatory Safety Stop is not completed the decompression model will penalize your next dive(s).



### 3.2.1.6. DECOMPRESSION DIVES

When your NO DEC TIME becomes zero, your dive becomes a decompression stop dive, i.e. you must perform one or several decompression stops on your way to the surface. The NO DEC TIME on your display will be replaced by a CEILING and blinking ASC TIME notation and an upward pointing arrow (Fig. 3.17.).

If you exceed the no-decompression limits on a dive, the dive computer will provide decompression information required for ascent. After this, the instrument will continue to provide subsequent interval and repetitive dive information.

Rather than requiring you to make stops at fixed depths, the dive computer gives you the option to decompress with a more gradual and natural series of mini steps within the decompression range (continuous decompression).

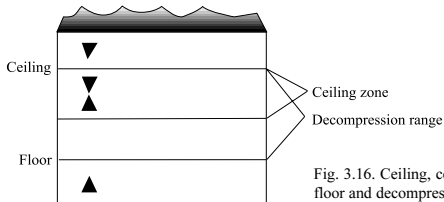

Fig. 3.16. Ceiling, ceiling zone, floor and decompression range.

The ascent time (ASC TIME) is the minimum amount of time needed to reach the surface in a decompression dive. It includes:

- time needed to ascend to the ceiling at an ascent rate of 10 m/min [33 ft/min] **plus**
- time needed at the ceiling. The ceiling is the shallowest depth where decompression could be made **plus**
- time needed at the Mandatory Safety Stop (if any) **plus**
- 3 minute Recommended Safety Stop **plus**
- time needed to reach the surface after the ceiling and safety stops have been completed.

## WARNING

Your ascent time may increase if you:

- ascend slower than 10 m/min [33 ft/min] or
- make your decompression stop deeper than at the ceiling.

These factors will also increase the amount of air required to reach the surface.

## CEILING, CEILING ZONE, FLOOR AND DECOMPRESSION RANGE

When in decompression, it is important that you understand the meaning of ceiling, floor, and decompression range (Fig. 3.16.):

- The ceiling is the shallowest depth where decompression could be made. At this depth, or below, you must perform all stops.
- The ceiling zone is the optimum decompression stop zone. It is the zone between the minimum ceiling and 1.8 m [6 ft] below the minimum ceiling.
- The floor is the deepest depth at which the decompression stop time will not increase. Decompression will start when you pass this depth during your ascent.
- The decompression range is the depth range between the ceiling and floor. Within this range, decompression takes place. However, it is important to remember that the decompression will be very slow at, or close to, the floor.

The depth of the ceiling and floor will depend on your dive profile. The ceiling depth will be fairly shallow when you enter the decompression mode, but if you remain at depth, it will move downward and the ascent time will increase. Likewise, the floor and ceiling may change upwards while you are decompressing.



Fig. 3.17. Decompression dive, below floor. Upward pointing arrow, blinking ASC TIME label and an audible alarm tell you to ascend. Minimum total ascent time including safety stop is 7 minutes. Ceiling is at 3 m [10 ft].

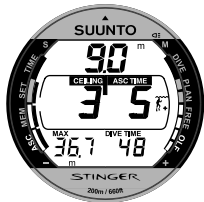

Fig. 3.18. Decompression dive, above floor. Upward pointing arrow has disappeared and ASC TIME label has stopped blinking, which means that you are in the decompression range.

When conditions are rough, it may be difficult to maintain a constant depth near the surface. In this case it will be more manageable to maintain an additional distance below the ceiling, to make sure that the waves do not lift you above the ceiling. Suunto recommends that decompression takes place deeper than 4 m [13 ft], even if the indicated ceiling is shallower.

**NOTE:** It will take more time and more air to decompress below the ceiling than at the ceiling.

## WARNING

Never ascend above the ceiling! You must not ascend above the ceiling during your decompression. In order to avoid doing so by accident, you should stay somewhat below the ceiling.

## DISPLAY BELOW THE FLOOR

The blinking ASC TIME and an upward pointing arrow indicate that you are below the floor (Fig. 3.17.). You should start your ascent immediately. The ceiling depth is shown on the left and the minimum total ascent time on the right side of the center window.

## DISPLAY ABOVE THE FLOOR

When you ascend above the floor, the ASC TIME display stops blinking and the upward pointing arrow disappears (Fig. 3.18.). Decompression will now begin, but is very slow. You should therefore continue your ascent.

## DISPLAY AT THE CEILING ZONE

When you reach the ceiling zone, the display will show you two arrows pointing at each other (the "hour glass" icon, Fig. 3.19.). Do not ascend above this zone.

During the decompression stop, ASC TIME will count down towards zero. When the ceiling moves upwards, you can ascend to the new ceiling. You may surface



Fig. 3.19. Decompression dive, at ceiling zone. Two arrows point at each other ("hour glass"). You are in the optimum ceiling zone at 3.5 m [11 ft] and your minimum ascent time is 5 minutes.



Fig. 3.20. Decompression dive, above ceiling. Note downward pointing arrow, Er warning and an audible alarm. You should immediately (within 3 minutes) descend to or below ceiling.

only after the ASC TIME and CEILING labels have disappeared, which means that the decompression stop and any Mandatory Safety Stop has been completed. You are advised, however, to stay until the STOP sign has also gone. This indicates that the three minute Recommended Safety Stop has also been completed.

## DISPLAY ABOVE THE CEILING

If you ascend above the ceiling during a decompression stop, a downward pointing arrow will appear and a continuous beeping starts (Fig. 3.20.). In addition, an error warning Er reminds you that you have only three minutes to correct the situation. You must immediately descend to or below the ceiling.

If you continue to violate the decompression, the dive computer goes into a permanent Error Mode. In this mode the instrument can only be used as a depth gauge and timer. You must not dive again for at least 48 hours (see chapter 3.2.5.).

## 3.2.2. DIVING WITH EAN (NITROX)

### 3.2.2.1. BEFORE DIVING

This dive computer can be set for diving with standard air only (Air mode) or it can be set for diving with Enriched Air Nitrox (EAN mode).

If set to the EAN mode, the correct oxygen percentage of the gas in your cylinder must always be entered into the computer to ensure correct nitrogen and oxygen calculations. The dive computer adjusts its mathematical nitrogen and oxygen calculation models according to the entered  $O_2\%$  value (Fig. 3.21.). Calculations based on Nitrox result in longer no-decompression times and shallower maximum depths.

### DEFAULT NITROX SETTINGS

In the EAN mode, the default setting is for standard air (21%  $O_2$ ). It remains in this setting until the  $O_2\%$  is adjusted to any other percentage of oxygen (22% - 50%).

If a dive is started within 2 hours Stinger retains this value until the dive series is finished. If unused, the computer will retain the manually entered value for the selected oxygen percentage for about two hours, after which it will revert to the default setting of 21%  $O_2$ .

The default setting for maximum oxygen partial pressure is 1.4 bar, however you are able to set it in the range of 1.2 - 1.6 bar.



Fig. 3.21. Nitrox display. Maximum depth based on set  $O_2\%$  (21%) and  $PO_2$  (1.4 bar) is 54.1 m [177 ft].

### 3.2.2.2. PRESETTING THE DISPLAYS IN THE EAN MODE

When entering the EAN mode the oxygen percentage and partial pressure are always the default displays in the lower part of the display.

Preset with the - button in the lower left corner of the display (Fig. 3.22.):

- oxygen percentage (default)
- the maximum depth or
- the temperature.

Preset with the + button in the lower right corner of the display (Fig. 3.22.):

- current oxygen partial pressure
- the dive time or
- the current time.

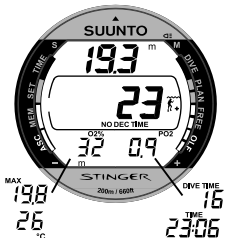

Fig. 3.22. Diving in EAN mode. The  $O_2\%$  is set to 32%.



### 3.2.2.3. OXYGEN DISPLAYS

If set to EAN mode the NITROX display, with all labeled oxygen information, is shown immediately after activation. The nitrox display shows (Fig. 3.21.):

- oxygen percentage, labeled with  $O_2\%$ , is shown in the left side of the lower display
- set oxygen partial pressure limit, labeled with  $PO_2$ , is shown in the right side of the lower display
- maximum allowed depth based on the set oxygen percentage and partial pressure limit
- current oxygen toxicity exposure shown with an Oxygen Limit Fraction (OLF) bar graph along the right side of the display.

In the Dive mode the current oxygen toxicity exposure is always shown with an Oxygen Limit Fraction (OLF) bar graph and the oxygen percentage labeled with  $O_2\%$ . The current oxygen partial pressure labeled with  $PO_2$  is also shown, if selected (Fig. 3.22.). During a dive, the oxygen partial pressure, labeled with  $PO_2$ , is always shown instead of the preselected display, if the partial pressure is greater than 1.4 bar or the set value (Fig. 3.23.).



Fig. 3.23. Oxygen partial pressure and OLF displays. There is an audible alarm and the last segment of the bar graph starts to blink as the OLF has reached 80% limit. When OLF has reached 100%, all segments starts to blink. If the OTU value is higher than the CNS value, the lowest segment blinks.

#### **3.2.2.4. OXYGEN LIMIT FRACTION (OLF)**

In addition to tracking the diver's exposure to nitrogen, the instrument tracks the exposure to oxygen. These calculations are treated as entirely separate functions.

The dive computer calculates separately for Central Nervous System oxygen toxicity (CNS) and Pulmonary Oxygen toxicity, the latter measured by the addition of Oxygen Toxicity Units (OTU). Both fractions are scaled so that the maximum tolerated exposure for each is expressed as 100%.

The Oxygen Limit Fraction (OLF) bar graph has 7 segments, each representing 12,5% (from 1 to 50%) or 15% (from 50% to 80%). The OLF bar graph displays only the value of the higher of the two calculations. When the OTU value meets and exceeds the CNS value then in addition to displaying its percentage the lowest segment blinks to indicate that the value shown relates to OTU. The oxygen toxicity calculations are based on the factors listed in chapter 7.3. "Oxygen Exposure".

### **3.2.3. AT THE SURFACE**

#### **3.2.3.1. SURFACE INTERVAL AFTER AN AIR/EAN DIVE**

An ascent to any depth shallower than 1.2 m [4 ft] will cause the DIVING display to be replaced by the alternating SURFACE displays, giving the following information (Fig. 3.24. and 3.25.):

- maximum depth of most recent dive in meters [ft]
- present depth in meters [ft]
- the surface time in hours and minutes (separated by a colon), telling the duration of the present surface interval
- the desaturation/no-flying time in hours and minutes is shown next to the airplane in the center window of the display
- no-flying warning indicated by an airplane icon
- Altitude Adjustment setting
- Personal Adjustment setting
- Diver Attention symbol indicates if you should prolong your surface interval time
- STOP label for 5 min, if the Mandatory Safety Stop was violated
- ASC TIME, if the decompression ceiling was violated (= Error Mode) (Fig. 3.26.)



Fig. 3.24. Surface display. You have surfaced from a 18 minute dive, which maximum depth was 20.0 m [66 ft]. The present depth is 0.0 m [0 ft] and surface interval time is 0. Airplane symbol indicates that you should not fly and diver attention symbol indicates that you should prolong your surface interval time because of excess micro-bubbles.

Or in the lower display according the selection and mode:

- dive time of most recent dive in minutes labeled with DIVE TIME.
- the current time labeled with TIME
- oxygen partial pressure labeled with  $PO_2$  (if set to EAN mode)
- maximum depth labeled with MAX
- the current temperature with  $^{\circ}C$  for Centigrade [or  $^{\circ}F$  for Fahrenheit]
- oxygen percentage setting labeled with  $O_2\%$  (if set to EAN mode)

If set to EAN mode, the current oxygen toxicity exposure is shown with an Oxygen Limit Fraction (OLF) bar graph along the right side of the display.



Fig. 3.25. Surface display. Alternating display showing the no-flying time.

### 3.2.3.2. DIVER ATTENTION SYMBOL

The Diver Attention Symbol is an advice to extend surface interval. Some patterns of diving, in particular multiday diving with many dives and short surface intervals, cumulatively add a higher risk of DCI. When this is detected in addition to adapting the decompression algorithm, the Diver Attention Symbol is shown.

### 3.2.3.3. DIVE NUMBERING

Several repetitive dives are considered to belong to the same repetitive dive series when the dive computer has not counted the no-flying time to zero. Within each series, the dives are given individual numbers. The first dive of the series will be numbered as DIVE 1, the second as DIVE 2, the third as DIVE 3, etc.

If you start a new dive with less than 5 minutes of surface interval time, the dive computer interprets this as a continuation of the previous dive and the dives are considered to be the same. The diving display will return, the dive number will remain unchanged, and



Fig. 3.26. Surface Mode after a violated decompression dive. ASC TIME symbol indicates that you have violated the ceiling for more than three minutes. The alternating display shows you that you must not dive again for at least 48 hours.



Diver Attention Symbol



Violated Decompression Ceiling



Do Not Fly Symbol

the dive time will begin where it left off. After 5 minutes on the surface, subsequent dives are, by definition, repetitive. The dive counter displayed in the Planning Mode will increment to the next higher number if another dive is made.

### **3.2.3.4. FLYING AFTER DIVING**

The no-flying time is shown in the center window next to the airplane image. Flying or travelling to a higher altitude should be avoided at any time the computer counts down the no-flying time.

The no-flying time is always at least 12 hours or equivalent to the so-called desaturation time (if longer than 12 hours).

In the permanent Error mode and Free/Gauge mode the no-flying time is 48 hours.

Divers Alert Network (DAN) recommends the following on no-flying times:

- A minimum surface interval of 12 hours would be required in order to be reasonably assured a diver will remain symptom free upon ascent to altitude in a commercial jetliner (altitude up to 2400 m [8000 ft]).
- Divers who plan to make daily, multiple dives for several days, or make dives that require decompression stops, should take special precautions and wait for an extended interval beyond 12 hours before flight. Further, the Undersea and Hyperbaric Medical Society (UHMS) suggests divers using standard air tanks and exhibiting no symptoms of decompression illness wait 24 hours after their last dive to fly in an aircraft with cabin pressure up to 2400 m [8000 ft]. The only two exceptions to this recommendation are:

- If a diver had less than 2 hours total accumulated dive time in the last 48 hours, then a 12 hour surface interval before flying is recommended.
- Following any dive that required a decompression stop, flying should be delayed for at least 24 hours, and if possible, for 48 hours.
- Suunto recommends that flying is avoided until all the DAN and UHMS guidelines and the dive computer wait to fly conditions are satisfied.



### **3.2.4. HIGH ALTITUDE DIVES AND PERSONAL ADJUSTMENT**

The dive computer can be adjusted both for diving at altitude and also to increase the conservatism of the mathematical nitrogen model.

#### **3.2.4.1. ALTITUDE ADJUSTMENT**

When programming the instrument for the correct altitude, you need to select the correct Altitude Mode according to Table 3.3. The dive computer will adjust its mathematical model according to the entered altitude mode, giving shorter no-decompression times at higher altitudes (see chapter 7.1., Table 7.1. and 7.2.).

TABLE 3.3. ALTITUDE ADJUSTMENT RANGES

<b><i>Altitude mode</i></b>	<b><i>Symbol on display</i></b>	<b><i>Altitude range</i></b>
<i>A0</i>		<i>0 - 300 m [0 - 1000 ft]</i>
<i>A1</i>		<i>300 - 1500 m [1000 - 5000 ft]</i>
<i>A2</i>		<i>1500 - 3000 m [5000 - 10000]</i>

The entered Altitude Adjustment Mode is indicated by mountain symbols (A0, A1 = one mountain, or A2 = two mountains). Also, the maximum altitudes are displayed for each Altitude group (see Table 3.3.). Chapter 4.6. describes how the Altitude Mode is adjusted.

Traveling to a higher elevation can temporarily cause a change in the equilibrium of dissolved nitrogen in the body. It is recommended that you acclimate to the new altitude by waiting at least three hours before making a dive.



### 3.2.4.2. PERSONAL ADJUSTMENT

There are adverse personal factors for DCI which divers can predict in advance and input into the decompression model. Factors that may affect susceptibility to decompression illness vary between divers and also for the same diver from one day to another. The three-step Personal Adjustment Mode is available, if a more conservative dive plan is desired.



The personal factors which tend to increase the possibility of DCI include, but are not limited to:

- cold exposure - water temperature less than 20 °C [68 °F]
- the diver is below average physical fitness level
- diver fatigue
- diver dehydration
- previous history of DCI
- stress
- obesity

The Personal Adjustment Mode is indicated by a diver symbol and plus signs (P0 = a diver, P1 = diver +, or P2 = diver ++). Chapter 4.6. describes how the Personal Mode is adjusted.

This feature should be used to adjust the computer to be more conservative, according to personal preference, by entering the suitable Personal Adjustment Mode with the help of Table 3.4. In ideal conditions, retain the default setting, P0. If conditions are more difficult or other mentioned factors which tend to increase the possibility of DCI exist, select P1 or even the most conservative P2. As a result the dive computer adjusts its mathematical model according to the entered Personal Adjustment Mode, giving shorter no-decompression times (see chapter 7.1., Table 7.1. and 7.2.).

TABLE 3.4. PERSONAL ADJUSTMENT RANGES

<b>Personal mode</b>	<b>Symbol on display</b>	<b>Condition</b>	<b>Desired tables</b>
<i>P0</i>		<i>Ideal condition</i>	<i>Default</i>
<i>P1</i>		<i>Some mentioned factors or conditions exist</i>	<i>Progressively more conservative</i>
<i>P2</i>		<i>Several mentioned factors or conditions exist</i>	

### **3.2.5. ERROR CONDITIONS**

The dive computer has warning indicators that alert the user to react to certain situations that would significantly increase the risk of DCI. If you do not respond to its warnings, the dive computer will enter an Error Mode, indicating that the risk of DCI has greatly increased. If you dive sensibly, it is very unlikely you will ever put the instrument into the Error Mode.

#### **OMITTED DECOMPRESSION**

The Error Mode results from omitted decompression, i.e. when you stay above the ceiling for more than three minutes. During this three-minute period the Er warning is shown and the audible alarm beeps. After this, the dive computer will enter a permanent Error Mode. The instrument will continue to function normally if you descend below the ceiling within this three-minute period.

Once in the permanent Error Mode only the Er warning is shown in the center window. The dive computer will not show times for ascent or stops. However, all the other displays will function as before to provide information for ascent. You should immediately ascend to a depth of 3 to 6 m [10 to 20 ft] and remain at this depth until air supply limitations require you to surface.

The Error mode will stay for 48 hours, during which time you should not dive. Whilst Stinger is in Error mode the ASC TIME label will be displayed in the center window and the Planning Mode will be disabled.

## **3.3. FREE / GAUGE MODE**

### **3.3.1. BEFORE DIVING IN THE FREE/GAUGE MODE**

If set to Free/Gauge mode, the dive computer can be used for freediving or diving with technical diving mixed gases. If you are trained for free or technical diving and you plan to use Free/Gauge mode on a regular basis, it may be preferable to disable the Air/EAN mode to set the instrument permanently to its Free/Gauge mode (see chapter 4.3.).

The default sampling interval for the logbook profile memory in the Free/Gauge mode is 4 seconds, but it can be set to 2, 10, 20, 30 or 60 seconds. This can be done in the Free setting mode (see chapter 4.4). It is advisable to use the short sampling rates for freediving but the longer ones (10 to 60s) for Scuba diving. Shorter intervals enable more accurate stored dive profiles. If your sampling rate is less than 10 seconds, your maximum dive time is 200 minutes.

The Dive Time display in the center window can be changed during a dive to become a stopwatch. When this stopwatch option is used the center display cannot be reset to Dive Time during the current dive. Using the stopwatch function has no effect on another Dive Time setting which can be preset or called up in the user definable display.

**NOTE:** The number of hours of dive time available depends on the sampling rate. A computer set to record depth every 4 seconds will fill its memory sooner than the same computer set to 30 seconds. The number of available hours also depends on the length of each dive. Fewer longer dives means more total hours of dive time available in the memory than does a large number of short dives.

**NOTE:** The dive time shown on the Logbook/Profile memory is always shorter or equal to the dive time shown in the surface display depending on the sampling rate.

If set to Free/Gauge mode the text FREE is shown after activation (Fig. 3.27.)



Fig. 3.27. Free/Gauge Mode.

### 3.3.2. PRESETTING THE DISPLAYS IN THE FREE/GAUGE MODE

Preset with the - button in the lower left corner of the display (Fig. 3.28.)

- the maximum depth or
- the temperature.

Preset with the + button in the lower right corner of the display (Fig. 3.28.)

- the dive time,
- the current time or
- the dive number.

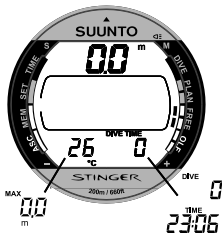

Fig. 3.28. Surface display/  
Alternative display.



Fig. 3.29. Free dive. Present depth is 6.1 m, dive time 1.03 min and dive number is 1.

### 3.3.3. FREEDIVING

In the Free/Gauge mode the present depth is always shown. Maximum depth and temperature or dive time, current time and dive number are shown in the alternative displays.

In addition to the Dive Time display in the lower right corner of the display, the Free Dive Time in minutes and seconds is shown in the center window (Fig. 3.29.) By pressing the S button you get a bookmark

### 3.3.3.1. FREEDIVING DAY HISTORY

It is possible at any time in the Free Surface Mode to enter the Freediving Day History Mode, simply by pressing the **S** button. After showing the text DAY HIS and the mode indicator (Fig. 3.30.), the display will show (Fig. 3.31.):

- the total amount of free dives,
- the longest free dive in minutes and seconds in the center window and
- the deepest free dive made during that day.

The Day His Mode can be canceled by pressing the **M** or the **S** button.



Fig. 3.30. Freediving Day History.



Fig. 3.31. Day History display.

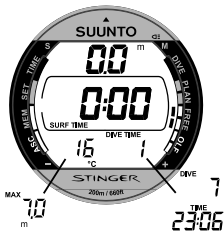

Fig. 3.32. Surface display after Free dive. Center window showing surface time.

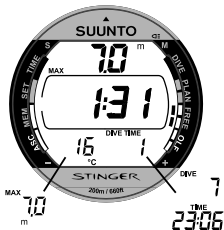

Fig. 3.33. Alternating surface display after Free dive. Center window showing the dive time of the most recent dive.

### 3.3.4. GAUGE MODE

The Free mode automatically changes to Gauge mode when the dive time exceeds five minutes for a single dive. In addition to the displays shown in the Free mode the Ascent Rate indicator is now enabled.

In the Free/Gauge mode the Dive Time in the center window can also be used as an automatic Stop Watch. When the SELECT button is pressed during the dive:

- A special mark, bookmark is written in the profile memory.
- The Dive Time shown in the center window is stopped, reset and started again.

**NOTE:** If you make a Gauge mode dive, it is not possible to change between the modes within 48 hours.



### 3.3.5. SURFACE INTERVAL AFTER A FREE/GAUGE DIVE

An ascent to any depth shallower than 1.2 m [4 ft] will cause the DIVING display to be replaced by the SURFACE display, giving the following information (Fig. 3.32. and 3.34.):

- maximum depth of most recent dive in meters [ft]
- present depth in meters [ft]
- the surface time in hours and minutes (separated by a colon), telling the duration of the present surface interval.

#### AFTER A FREEDIVE:

- dive time of most recent dive in minutes and seconds in the center window (Fig. 3.33.).



Fig. 3.34. Surface display after Gauge dive. Center window showing surface time.



Fig. 3.35. Alternating display after Gauge dive. Center window showing the no-flying time.

## AFTER A SCUBA DIVE IN THE GAUGE MODE:

- the no-flying time in hours and minutes is shown next to the airplane in the center window of the display (Fig. 3.35.)
- no-flying warning indicated by an airplane icon.

Or in the lower display according the selection:

- dive time of the most recent dive in minutes labeled with DIVE TIME.
- the current time labeled with TIME
- the dive number labeled with DIVE
- maximum depth labeled with MAX
- the current temperature with °C for Centigrade [or °F for Fahrenheit].

**NOTE:** After a Gauge mode dive the no-flying time is always 48 h.

**NOTE:** Dive numbering in the Free/Gauge mode is different than in the Air/EAN mode. It is based on repetitive dives made during one day. The dive number is zeroed at midnight.

### 3.4. AUDIBLE AND VISUAL ALARMS

The dive computer features audible and visual alarms to advise when important limits are approached or to acknowledge preset alarms.

#### **A short single beep occurs when:**

- when the dive computer automatically returns to the Time mode.

#### **Three single beeps with a two second interval and the backlight activated for 5 seconds occur when:**

- the no-decompression dive turns into a decompression stop dive. An arrow pointing upwards and the blinking ascent warning ASC TIME will appear (Fig. 3.17.).

#### **Continuous beeps and the backlight activated for 5 seconds occur when:**

- the maximum allowed ascent rate, 10 m/min [33 ft/min], is exceeded. SLOW and STOP warnings will appear (Fig. 3.15.).
- the Mandatory Safety Stop ceiling is exceeded. A downward pointing arrow will appear (Fig. 3.14.).
- the decompression ceiling depth is exceeded. An error warning Er and a downward pointing arrow appear. You should immediately descend to, or below, the ceiling. The instrument will otherwise enter a permanent Error Mode within three minutes, indicated by a permanent Er (Fig. 3.20.).

You are able to preset alarms before the actual dive. The user programmable alarms can be set for maximum depth, dive time and daily time. The alarms activate when:

- The preset maximum depth is reached
  - continuous beep series for 24 seconds or until any button is pressed.
  - the maximum depth blinks as long as the present depth value exceeds the adjusted value.
- The preset dive time is reached
  - continuous beep series for 24 seconds or until any button is pressed.
  - the dive time blinks for one minute, if no button is pressed.
- The preset alarm time is reached
  - the current time is shown.
  - continuous beep series for 24 seconds or until any button is pressed.
  - the current time blinks for one minute, if no button is pressed.

## OXYGEN ALARMS IN EAN MODE

### **Three double beeps and the backlight activated for 5 seconds occur when:**

- the OLF bar graph reaches 80%. The segments exceeding the 80% limit start to blink (Fig. 3.23.)
- the OLF bar graph reaches 100%. All the OLF bar graph segments start to blink.

The blinking of the segments will stop when the OLF is not loading anymore. At that point the  $PO_2$  is less than 0.5 bar.

**Continuous beeps for 3 minutes and the backlight activated for 5 seconds occur when:**

- the set oxygen partial pressure limit is exceeded. The maximum depth is replaced with the current blinking  $PO_2$  value. You should immediately ascend above the  $PO_2$  depth limit (Fig. 3.23.).

**WARNING**

When the oxygen limit fraction indicates that the maximum limit is reached, you must immediately ascend until the warning stops blinking! Failure to take action to reduce oxygen exposure after the warning is given can rapidly increase the risk of oxygen toxicity and the risk of injury or death.



Fig. 4.1. The Setting Mode is indicated by the SET text and mode indicator.

## 4. SETTING MODE [SET]

The time, date, dual time, daily alarm, scuba and free dive selections and settings, dive time and depth alarms and the altitude, personal and unit adjustments are set in the Setting Mode (Fig. 4.1.).

Enter the Setting Mode from other modes by pressing the **M** button. The text SET at the bottom and the mode indicator on the left side of the display indicate the selected mode



Fig. 4.2. Time Adjustment Mode.

### 4.1. SETTING TIME, DATE AND DUAL TIME [TIME ]

To set the time and date:

1. In the Setting Mode, press **S** to select the Time Adjustment Mode (Fig. 4.2.).
2. Wait two seconds until the Time Adjustment Mode activates automatically. The time mode indicator appears and the second digits start to blink on the display (Fig. 4.3.).

3. Press **S** to change the selection in the following sequence:

-> seconds -> hours -> minutes -> 12/24 hour format  
-> year -> month -> day -> dual (home) time hours -> minutes

4. While the second digits are selected (blinking), press - to reset the seconds to "00" or press + to increase the value.

5. While any other digits (except seconds) are selected (blinking), press + to increase the value or - to decrease it. Holding the button the current selection starts to scroll.

6. After you have set the time and date, press the **M** button to save the settings and to return to the Setting Mode [SET].

**NOTE:**

- The day of the week is automatically calculated in accordance with the date.
- The date can be set within the range of Jan 1, 1990 to Dec. 31, 2089.



Fig. 4.3. The Time Adjustment Mode is activated and the second digits are blinking. Page I.



Fig. 4.4. The year, month and day is selected. Page II. Dual time selected. Page III.



Fig. 4.5. Daily alarm Setting Mode.



Fig. 4.6. Daily Alarm Setting Mode is activated.

## NOTE:

- While the selection is blinking and no button is operated within 10 minutes, the blinking stops and the Stinger beeps and returns automatically to the timekeeping display.
- The display is illuminated by holding down the **M** button for more than two seconds.

## 4.2. DAILY ALARM SETTING [ALM]

You can set one daily alarm in the Stinger. When the daily alarm activates, the 📍-symbol blinks for 1 minute and the alarm sounds for 24 seconds. The alarm is given at the preset time each day. Press any button to stop the audible alarm, after it has activated.

To set the daily alarm:

1. In the Setting Mode, press **S** two (2) times to select the Daily alarm Setting Mode (Fig. 4.5.).
2. Wait two seconds until the Daily Alarm Setting Mode activates automatically. The time mode indicator appears and the alarm status [On/OFF] starts to blink on the display (Fig. 4.6.).



3. Press **S** to change the selection in the following sequence:

-> On/OFF status -> hours -> minutes

4. While the alarm status [On/OFF] is selected (blinking) press + or - to change the status. When the alarm status is On, the daily alarm indicator (🔔-symbol) in the bottom right corner of the display indicates that the alarm is on.

5. Set the other sections as follows:

- While any other digits (except alarm status) are selected (blinking), press + to increase the value or - to decrease it. Holding down either button starts the scrolling of the current selection.

- The 12-hour or 24-hour format of the alarm matches the format of the timekeeping display, which is selected in the Time Adjustment Mode (see chapter 4.1.). When using the 12-hour format of the alarm, take care to set the time correctly as morning (AM) or afternoon (PM).

6. After you have set the daily alarm, press the **M** button to save the settings and to return to the Setting Mode [SET].



Fig. 4.7. EAN/Air Setting Mode.

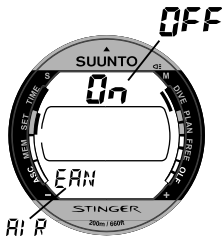

Fig. 4.8 The enable/disable status of the EAN Mode.

### 4.3. AIR AND ENRICHED AIR NITROX SETTINGS [EAN]

In this setting mode you can either select one scuba dive mode (standard air and enriched air nitrox) or disable both. If you select ON then you have a choice of whether to have either Standard Air or Enriched Air Nitrox as the operating option.

If set to the EAN (Nitrox) mode, the correct oxygen percentage of the gas in your cylinder must always be entered into the computer to ensure correct nitrogen and oxygen calculations. Also in EAN mode, the oxygen partial pressure limit must be set. When in the EAN Setting mode the equivalent allowed maximum depth based on the chosen setting will also be displayed.

To set the Air/EAN:

1. In the Setting Mode, press **S** three (3) times to select the EAN Setting Mode (Fig. 4.7.).
2. Wait two seconds until the EAN Setting Mode activates automatically. The enable/disable status [On/ OFF] starts to blink on the display (Fig. 4.8.).

3. Press **S** to change the selection in the following sequence:

-> On/OFF status -> EAN/AIR -> if EAN selected: Oxygen percentage ( $O_2\%$ ) -> Oxygen partial pressure ( $PO_2$ )

While the enable/disable status [On/OFF] is selected (blinking) press + or - to change the status. When the Air/EAN dive mode is selected (blinking) press + or - to change the mode. When Oxygen percentage ( $O_2\%$ ) or Oxygen partial pressure ( $PO_2$ ) are selected (blinking) press + or - to change the setting (Fig. 4.9.).

4. After you have set the EAN, press the **M** button to save the settings and to return to the Setting Mode [SET]

**NOTE:** If the EAN/Air mode is disabled (set to OFF), the instrument will not activate the scuba diving mode when submerged.



Fig. 4.9. Setting Oxygen Percentage and Partial Pressure.



Fig. 4.10. Free Setting Mode.



Fig. 4.11. The enable/disable status of the Free Mode and the recording rate setting.

## 4.4. FREEDIVING AND GAUGE SETTINGS [FREE]

In this setting mode you can select or disable the freedive mode and set the freedive sampling rate.

To set the FREE:

1. In the Setting Mode, press **S** four (4) times to select the Free Setting Mode (Fig. 4.10.).
2. Wait two seconds until the Free Setting Mode activates automatically. The enable/disable status [On/OFF] starts to blink on the display (Fig. 4.11.).
3. Press **S** to change the selection in the following sequence:

->On/OFF status -> Freediving recording rate in seconds

While the enable/disable status [On/OFF] is selected (blinking) press + or - to change the status. When the REC mode is selected (blinking) press + or - to change the setting. Available settings are 2, 4, 10, 20, 30, 60 seconds (Fig. 4.11.).



Fig. 4.12. Dive Alarm Setting Mode.

4. After you have set the FREE, press the **M** button to save the settings and to return to the Setting Mode [SET].

**NOTE:** If both the Air/EAN and Free modes are disabled (set to OFF), the instrument will not activate any diving mode when submerged.

## 4.5. DIVE ALARM SETTINGS [DIVE AL]

You can set one depth alarm in the Stinger. When the depth alarm activates, the ((■) symbol blinks as long as the present depth value exceeds the adjusted value and the alarm sounds for 24 seconds. Press any button to stop the audible alarm, after it has activated.

To set the depth alarm:

1. In the Setting Mode [SET], press **S** five (5) times to select the Dive Alarm Setting Mode (Fig. 4.12.).
2. Wait two seconds until the Dive Alarm Setting Mode activates automatically. The alarm status [On/OFF] starts to blink on the display (Fig. 4.13.).



Fig. 4.13. Dive Time Alarm. Center window displays less than 5 minutes dive time.

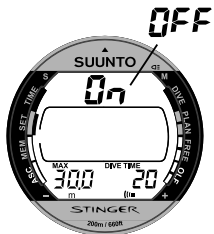

Fig. 4.14. Dive Time Alarm. Display when more than 5 minutes dive time left.



Fig. 4.15. Adjustment Mode.



Fig. 4.16. Setting Altitude Adjustment.

3. Press **S** to change the selection in the following sequence.

-> On/OFF status -> depth alarm limit -> dive time alarm minutes (-> dive time alarm seconds)

4. While the alarm status [On/OFF] is selected (blinking), press + or - to change the status. When the alarm status is On, the depth alarm indicator (■ symbol) in the bottom right corner of the display indicates that the alarm is on.

5. While the depth digits are selected (blinking), press + to increase the value or - to decrease it at intervals of 0.5 m [1 ft]. Holding down either button starts the scrolling of the depth value. The range of the depth is from 3.0 to 150 m [10 to 450 ft]. The default setting is 40m [131ft]. If set to 0, the alarm is disabled.

6. While the dive time minutes are selected (blinking), press + or - to change the time. If the time is less than five (5) minutes, the dive time alarm seconds can also be set. This feature can be used for freediving (Fig. 4.13.)

7. After you have set the depth alarm, press the **M** button to save the settings and to return to the Setting Mode [SET].

## 4.6. ALTITUDE, PERSONAL AND UNIT ADJUSTMENT SETTINGS

### [AdJ]

The current Altitude and Personal Adjustment Modes are shown when diving as well as at the surface. If the mode does not match the altitude or conditions (see chapter 3.2.4.), it is imperative that the diver enters the correct selection before diving. Use the Altitude Adjustment to select the correct altitude mode. Use the Personal Adjustment to add an extra level of conservatism. In this setting mode also the desired units can be selected (metric, m/°C or imperial, ft/°F).

**NOTE:** New altitude and personal adjustment selections cannot be made until 5 minutes after a scuba dive or 2 to 60 seconds after a free/gauge dive (depending on the sampling rate).

To set the new Altitude, Personal or Unit Adjustments:

1. In the Setting Mode [SET], press **S** six (6) times to select the Altitude, Personal and Unit Adjustment Mode (Fig. 4.15).



Fig. 4.17. Setting Personal Adjustment.

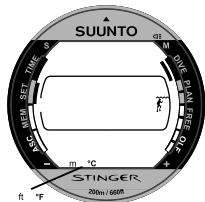

Fig. 4.18. Setting metric/imperial units.

2. Wait two seconds until the Adjustment Mode activates automatically. The altitude setting starts to blink on the display (Fig. 4.16.).
3. Press **S** to change the selection in the following sequence.  
-> altitude adjustment -> personal adjustment -> units
4. While the altitude digits are selected (blinking), press + or - to change the Altitude Mode (Fig. 4.16.).
5. While the personal adjustment digits are selected (blinking), press + or - to change the Personal Adjustment Mode (Fig. 4.17.).
6. While the units are blinking in the lower part of the display, press + or - to change units (Fig. 4.18.).
7. After you have set the desired adjustments, press the **M** button to save the settings and to return to the Setting Mode [SET] ).

## WARNING

Always recheck the personal and altitude adjustment to ensure that the altitude is not set for an altitude less than that of the dive site and that the personal mode corresponds to the desired conservatism. Failure to enter this information could result in dive planning errors and risk exposure to decompression sickness.



## 5. MEMORIES AND DATA TRANSFER [MEM]

The memory functions for the Stinger include the combined Logbook and Dive Profile Memory, Dive History Memories for scuba and free dives and the Data Transfer and PC-Interface functions.

**NOTE:** After diving, the memory mode cannot be accessed until 5 minutes after the dive.

Enter the Memory Mode [MEM] from other modes by pressing the **M** button. The text MEM at the bottom and the mode indicator on the left side of the display indicate the selected mode (Fig. 5.1.).

If any button is not operated within 5 minutes after a function of the Memory Mode is selected, the Stinger beeps and returns to the timekeeping display automatically.



Fig. 5.1. Memory Mode.

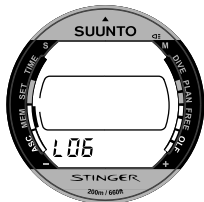

Fig. 5.2. Logbook memory mode.



Fig. 5.3. Logbook, page I.



Fig. 5.4. Logbook, page II. Main dive related data.

## 5.1. LOGBOOK AND DIVE PROFILE MEMORY [LOG]

This instrument has a very sophisticated high capacity Logbook and Profile Memory. The data is recorded to the profile memory based on the selected sampling rate. Dives shorter than the recording interval are not registered. You have the possibility to set the scuba diving sampling rate to 10, 20, 30 or 60 seconds with the optional PC-interface unit and software. The sampling rate in the Free/Gauge mode can be set separately to 2, 4, 10, 20, 30 or 60 seconds (see chapter 4.4.).

To enter the Logbook Memory Mode:

1. In the Memory Mode [MEM], press **S** to select the Logbook Memory Mode (Fig. 5.2.). The LOG text appears at the bottom of the display to indicate the selected mode.
2. Wait two seconds until the Logbook Memory Mode activates automatically. For each dive there are four pages of logbook dive information.
3. Press **S** to switch the display between Logbook display I, II, III and IV.

The data of the most recent dive is shown first. The END text is displayed after the oldest and most recent dive (Fig. 5.7.).

The following information will be shown on four pages:

**Page I, main display (Fig. 5.3.)**

- dive number in the dive series, Air/EAN dives are indicated by a D number and Free/Gauge by a F number
- dive entry time and date.

**Page II (Fig. 5.4.)**

- maximum depth  
(NOTE: Due to lower resolution, the reading may differ from the maximum depth reading of the Dive History or surface display up to 0.3 m [1 ft].)
- total dive time
- Altitude Adjustment setting (not displayed in Free/Gauge mode)
- Personal Adjustment setting (not displayed in Free/Gauge mode)
- Blinking SLOW, if the diver has violated the maximum ascent rate
- STOP label, if the Mandatory Safety Stop was violated
- ASC TIME label, if the dive was a decompression stop dive
- Diver attention symbol, if the dive was started while symbol was displayed
- downward pointing arrow, if the ceiling was violated
- oxygen percentage (only for nitrox dives)
- maximum OLF during the dive (only for nitrox dives).



Fig. 5.5. Logbook, page III. Surface interval time, average depth.



Fig. 5.6. Logbook, page IV. Profile of specific dive.

### Page III (Fig. 5.5.)

- average depth
- surface interval time before the dive
- temperature at the maximum depth

### Page IV (Fig. 5.6.)

- the profile of the dive, automatic scrolling during which:
- blinking diver attention symbol when the user has pressed the **S** button for Bookmark
- blinking SLOW and STOP label when registered
- blinking ASC TIME label when the dive became a decompression dive.

The data of the most recent dive is shown first. Press - to call the previous dive. Press the - button consecutively to move backward through the dives. When searching the dives, only Display I is shown. Press + to move forward through the dives. The END text is displayed after the oldest and the most recent dive (Fig. 5.7.).

The memory will always retain approximately the last 36 hours of dive time (with 20s sampling rate). After that, when new dives are added (after approximately 36 hours of diving), the oldest dives are deleted. The contents of the memory will remain even when the battery is changed (assuming that the replacement has been done according to the instructions).

## DIVE PROFILE MEMORY [PRO]

The scrolling of the profile will start automatically when the Profile/logbook page IV is entered (Fig. 5.6.).

The dive time is displayed in sampling increments with each display being shown for about three seconds. The depths shown are the maximum values of each sampling interval.

After the last depth figure of the selected profile, the Stinger automatically returns to Display I of the same dive in the Logbook. If desired, the profile of the same dive can be recalled again following the above procedure.



Fig. 5.7. Logbook, end of the memory. END text is displayed after oldest and the most recent dive.

The scrolling of the profile can be stopped by pressing any button.

- Press **S** to stop the scrolling and to return to Display I of the same dive in the Logbook.
- Press + to stop the scrolling and to change to Display I of the next dive in the Logbook.
- Press - to stop the scrolling and to change to Display I of the previous dive in the Logbook.
- Press **M** to stop the scrolling and to return to the beginning of the Logbook.
- Press **M** two (2) times to exit the Logbook Memory [LOG] and enter the Memory Mode [MEM].

**NOTE:** Several repetitive dives are considered to belong to the same repetitive dive series if the no-flying time has not ended. See "Dive Numbering" in chapter 3.2.3.3. for further information.

## 5.2. DIVE HISTORY MEMORY [HIS]

The Dive History is a summary of all the scuba and free dives recorded by the Stinger. To enter the Dive History Memory Mode:

1. In the Memory Mode [MEM], press **S** two (2) times to select the Dive History Memory Mode (Fig. 5.8.). The HIS text appears at the bottom of the display to indicate the selected mode.

2. Wait two seconds until the Dive History Memory Mode activates automatically. The following scuba dive information will be shown on the display (Fig. 5.9.):

- the maximum depth ever reached
- the total accumulated dive time in hours
- the total number of dives.

999 dives and 999 hours of diving can be registered. When these maximum values are reached, the counters will start again from 0.



Fig. 5.8. Dive History Memory.



Fig. 5.9. Scuba Dive History Memory. Total number of dives, dive hours and maximum depth.



Fig. 5.10. Free dive History Memory.

**NOTE:** The maximum depth can be reset to 0.0 m [0 ft] using the optional Suunto Dive Manager PC-Interface.

3. To enter the Free dive History Memory Mode press the - or + buttons once when the History Memory is selected. The following Free dive information will be shown on the display (Fig. 5.10.):

- the maximum depth ever reached
- the longest free dive time ever reached

### **5.3. DATA TRANSFER AND PC-INTERFACE [TR-PC]**

The Stinger can be connected to an IBM compatible personal computer (PC), using the optional SUUNTO PC-Interface and the SUUNTO DIVE MANAGER software. With the PC-Interface dive data from the Stinger can be downloaded to a PC. Data can be added to complete the logbook and paper copies of your dive log and profiles can easily be printed. The PC-Interface software can be used for educational and demonstration purposes, for planning dives, as well as for keeping complete record of your dive history with the Stinger.



The data transfer is carried out using the water contact of the Stinger. The following data is transferred to the PC:

- depth profile of the dive
- dive time
- preceding surface interval time
- dive number
- Altitude and Personal adjustment settings
- oxygen percentage setting and maximum OLF (in EAN mode)
- tissue calculation data
- temperature at the beginning of the dive, maximum depth and end of the dive
- dive entry time (year, month, day and time)
- additional dive information (e.g. SLOW and Mandatory Safety Stop violations, Diver Attention Symbol, Bookmarks, Surfaced Mark, Decompression Stop Mark, Ceiling Error Mark)
- dive computer serial number
- personal 30 character information.

It is also possible to manually add comments and other personal information to the PC based dive data files. The SUUNTO PC-Interface package comes complete with the interface unit, the software and an installation guide.

To enter the Data Transfer Mode:

1. In the Memory Mode [MEM], press **S** three (3) times to select the Data Transfer Mode. The TR-PC text appears at the bottom of the display to indicate the selected mode (Fig. 5.11.).
2. Wait two seconds until the Data Transfer Mode activates automatically.

**NOTE:** While in the Data Transfer Mode, the water contact is used only for the data transfer, and when connecting the contact by submerging it, the Dive Mode IS NOT automatically activated. Data transfer stops also the stopwatch.

After you have finished the data transfer, Press the **M** to exit Data Transfer Mode [TR-PC] and enter the Memory Mode [MEM]. If no button is operated or no data is transferred within 5 minutes, the Stinger beeps and returns to the timekeeping display automatically.

Using the PC software, you are able to enter setup options such as:

- change the sample rate for profile records/logbook from the default 20 second interval to 10, 30 or 60 seconds
- input a personal, 30 character field into the Stinger (i.e. your name)
- reset the Dive History's max depth to zero.

## **6. CARE AND MAINTENANCE**

This Suunto dive computer is a sophisticated precision instrument. Though designed to withstand the rigors of scuba diving, you must treat it with proper care and caution as any other precision instrument.

### **6.1. CARE OF YOUR STINGER**

- NEVER try to open the case of the Stinger or to remove the buttons.
- NEVER try to open the depth sensor cover.
- Every two years or after 500 dives (whichever comes first) have your Stinger serviced by an authorized dealer or distributor. This service will include cleaning of the unit, a general operational check, replacement of the battery and a water resistance check and if needed, replacement of the seals, buttons, spring bars, mineral crystal or bezel. The service requires special tools and training. It is advisable to contact an authorized SUUNTO dealer or distributor for this biennial service. Do not attempt to do any service that you are not sure about how to do.
- Should moisture appear inside the Stinger have it checked immediately by your SUUNTO dealer or distributor.
- Should you detect scratches, cracks or other such flaws on the mineral crystal window that may impair its durability, have it replaced immediately by your SUUNTO dealer or distributor.

- Check the spring bars holding the strap and the buckle for flaws. If the flexibility of the spring bars has reduced, have them replaced immediately by your SUUNTO dealer or distributor.
- Wash and rinse the unit in fresh water after every use. Particularly clean the water contact carefully.
- Protect the unit from shocks, extreme heat or direct sunlight and chemical attack. The Stinger cannot withstand the impact of heavy objects like scuba cylinders, nor chemicals like gasoline, cleaning solvents, aerosol sprays, adhesive agents, paint, acetone, alcohol etc. Chemical reactions with such agents will damage seals, case and finish.
- Store your Stinger in a dry place when you are not using it.
- The Stinger will display a battery symbol as a warning when the power gets too low. When this happens, the Stinger should not be used until the battery has been replaced by an authorized SUUNTO dealer or distributor (see chapter 3.1.1.).
- Do not fasten the strap of your Stinger too tightly. You should be able to insert your finger between the strap and your wrist. Use the extension strap when fastening the Stinger on your exposure suit.

## 6.2. MAINTENANCE

If left without care for an extended period, a thin film (often invisible to the eye) will cover the unit. Much like the buildup on the glass of an aquarium, this film is the result of organic contaminants found in both salt and fresh water. Suntan oil, silicone spray and grease will speed up this process. As a result of this buildup, moisture will be trapped next to the water contact and will not allow your Stinger to operate properly.

The water contact can be cleaned with a small brush (e.g. toothbrush).

**IMPORTANT:** The Stinger should be soaked, then thoroughly rinsed with fresh water and then dried with a soft towel after each dive. Make sure that all salt crystals and sand particles have been flushed out. Check the mineral crystal for possible moisture or water. **DO NOT** use the Stinger if you detect any moisture or water inside.

### CAUTION!

- do not use compressed air to blow water off the unit
- do not use solvents or other cleaning fluids that might cause damage
- do not test or use the Stinger in pressurized air.

### **6.3. WATER RESISTANCE INSPECTION**

Water resistance of the unit must be checked after replacement of the battery, mineral crystal window or buttons. The check requires special equipment and training.

You must frequently check the mineral crystal window for leaks. If you find moisture inside your advanced computer watch, there is a leak. A leak must be corrected without delay, as moisture will seriously damage the unit, even beyond repair. SUUNTO does not take any responsibility for damage caused by moisture in the Stinger, if the instructions of this manual are not carefully followed.

In case of a leak immediately bring the Stinger to an authorized SUUNTO dealer or distributor.

## 7. TECHNICAL DESCRIPTION

### 7.1. OPERATING PRINCIPLES

#### NO-DECOMPRESSION LIMITS

The no-decompression limits displayed by the dive computer for the first dive to a single depth (see Table 7.1. and 7.2.), are slightly more conservative than those permitted by the U.S. Navy tables.

TABLE 7.1. NO-DECOMPRESSION TIME LIMITS (MIN) FOR VARIOUS DEPTHS (M) FOR THE FIRST DIVE OF A SERIES









Depth [m]	Personal Mode / Altitude Mode								
	P0/A0 	P0/A1 	P0/A2 	P1/A0 	P1/A1 	P1/A2 	P2/A0 	P2/A1 	P2/A2 
9	--	163	130	163	130	96	130	96	75
12	124	89	67	89	67	54	67	54	45
15	72	57	43	57	43	35	43	35	29
18	52	39	30	39	30	25	30	25	21
21	37	29	23	29	23	20	23	20	15
24	29	24	19	24	19	16	19	16	12
27	23	18	15	18	15	12	15	12	9
30	18	14	12	14	12	9	12	9	7
33	13	11	9	11	9	8	9	8	6
36	11	9	8	9	8	6	8	6	5
39	9	8	6	7	6	5	6	5	4
42	7	6	5	6	5	4	5	4	4
45	6	5	5	5	5	4	5	4	3

TABLE 7.2. NO-DECOMPRESSION TIME LIMITS (MIN) FOR VARIOUS DEPTHS [FT] FOR THE FIRST DIVE OF A SERIES

Depth [ft]	Personal Mode / Altitude Mode								
	P0/A0 	P0/A1 	P0/A2 	P1/A0 	P1/A1 	P1/A2 	P2/A0 	P2/A1 	P2/A2 
30	--	160	127	160	127	93	127	93	73
40	120	86	65	86	65	53	65	53	43
50	69	56	41	56	41	34	41	34	28
60	51	38	29	38	29	25	29	25	20
70	36	29	23	29	23	20	23	20	15
80	28	23	19	23	19	15	19	15	11
90	22	18	15	18	15	11	15	11	9
100	17	14	11	14	11	9	11	9	7
110	13	11	9	11	9	7	9	7	6
120	10	9	8	9	8	6	8	6	5
130	9	7	6	7	6	5	6	5	4
140	7	6	5	6	5	4	5	4	4
150	6	5	4	5	4	4	4	4	3



## ALTITUDE DIVING

The atmospheric pressure is lower at high altitudes than at sea level. After traveling to a higher altitude, the diver will have additional nitrogen in his body, compared to the equilibrium situation at the original altitude. This "additional" nitrogen is released gradually in time and equilibrium is reached. It is recommended that you adapt to the new altitude by waiting at least three hours before making a dive.

Before high altitude diving, the instrument must be set to the Altitude Adjustment mode to adjust the calculations for the new altitude. The maximum partial pressures of nitrogen allowed by the mathematical model of the dive computer are reduced according to the lower ambient pressure.

As a result, the allowed no-decompression stop limits are considerably reduced.

## SURFACE INTERVALS

The dive computer requires a minimum surface interval of 5 minutes between dives in the Air/EAN mode. If a surface interval is shorter than 5 minutes, the next dive is treated as a continuation of the previous dive. In the Free/Gauge mode this surface interval is equivalent to the sampling rate.

## **7.2. REDUCED GRADIENT BUBBLE MODEL, SUUNTO RGBM**

The Suunto Reduced Gradient Bubble Model (RGBM) is a modern algorithm for predicting both dissolved and free gas in the tissues and blood of divers. It was developed in a co-operation between Suunto and Bruce R. Wienke BSc, MSc, PhD. It is based on both laboratory experiments and diving data, including data from DAN.

It is a significant advance on the classical Haldane models, which do not predict free gas (microbubbles). It incorporates consistency with real physical laws for gas kinetics. The advantage of Suunto RGBM is additional safety through its ability to adapt to a wide variety of situations. Suunto RGBM addresses a number of diving circumstances outside the range of just dissolved gas models by:

- Monitoring continuous multiday diving
- Computing closely spaced repetitive diving
- Reacting to a dive deeper than the previous dive
- Adapting for rapid ascents which produce high micro-bubble (silent-bubble) build-up.

## SUUNTO RGBM ADAPTIVE DECOMPRESSION

The Suunto RGBM algorithm adapts its predictions of both the effects of micro-bubble build-up and adverse dive profiles in the current dive series. It will also change these calculations according to the personal adjustment you select.

The pattern and speed of decompression at the surface is adjusted according to micro-bubble influence.

Also on repetitive dives adjustment may be applied to the maximum allowable nitrogen overpressure in each theoretical tissue group.

Depending on circumstances Suunto RGBM will adapt the decompression obligations by doing any or all of the following:

- Reducing no-decompression stop dive times
- Adding Mandatory Safety Stops
- Increasing decompression stop times
- Advising an extended surface interval (Diver Attention symbol).

## DIVER ATTENTION SYMBOL - ADVICE TO EXTEND SURFACE INTERVAL

Some patterns of diving cumulatively add a higher risk of DCI, e.g. dives with short surface intervals, repetitive dives deeper than earlier ones, multiple ascents, substantial multiday diving. When this is detected in addition to adapting the decompression algorithm Suunto RGBM will in some circumstances also advise, with the Diver Attention Symbol (review chapter 3.2.3.2.) that the diver extend the surface interval.

### 7.3. OXYGEN EXPOSURE

The oxygen exposure calculations are based on currently accepted exposure time limit tables and principles. In addition to this the dive computer uses several methods to conservatively estimate the oxygen exposure. These include for example:

- the displayed oxygen exposure calculations are rounded to the next higher whole percentage value
- for recreational scuba diving, the recommended upper limit of 1.4 bar  $PO_2$  is used as a default
- the CNS% limits up to 1.4 bar are based on 1991 NOAA Diving Manual limits, but the limits higher than 1.4 bar are significantly shortened
- the OTU monitoring is based on the long-term daily tolerance level and the recovery rate is reduced.

The oxygen related data and warnings are provided at all appropriate phases of a dive. The following information will be shown before and during a dive, when the computer is set in EAN mode:

- the selected O<sub>2</sub>%
- the color-coded OLF% bar graph for either CNS% or OTU%
- audible alarms are given and the OLF bar graph starts to blink when the 80% and 100% limits are exceeded
- the blinking of the bar graph stops, when the PO<sub>2</sub> is below 0.5 bar
- audible alarms are given and the actual PO<sub>2</sub> value blinks when it exceeds the preset limit
- in dive planning the maximum depth limit according to the O<sub>2</sub>% and maximum PO<sub>2</sub> selected.

## 7.4. TECHNICAL SPECIFICATION

### Dimensions and weight:

- Diameter: 46 mm [1.81 in]
- Thickness: 15 mm [0.59 in]
- Weight: 110 g [3.9 oz] with elastomer strap
- Weight: 186 g [6.6 oz] with stainless steel bracelet
- Weight Titanium: 87 g [3.07 oz] with elastomer strap
- Weight Titanium: 132 g [4.66 oz] with Titanium bracelet

### Depth Gauge:

- Temperature compensated pressure sensor.
- Salt water calibrated, in fresh water the readings are about 3% smaller (calibrated complying with prEN 13319).
- Maximum depth of operation: 80 m [262 ft] (complying with prEN 13319).
- Accuracy:  $\pm 1\%$  of full scale or better from 0 to 80 m [262 ft] at 20°C [68°F] (complying with prEN 13319).
- Depth display range: 0 ... 150 m [492 ft].
- Resolution: 0.1 m from 0 to 100 m, 1 m from 100 to 150 m [1 ft from 0 to 492 ft].

### Temperature display:

- Resolution: 1°C [1.5 °F]
- Display range: - 20 ... +50 °C [- 4 ... +122 °F]
- Accuracy:  $\pm 2$  °C [ $\pm 3.6$  °F] within 20 minutes of temperature change

### Calendar Clock:

- Accuracy:  $\pm 15$  s /month (at 20°C [68°F])
- 12/24 h display

### Other displays:

- Dive time: 0 to 999 min or 0 to 200 with sampling rates less than 10 sec., counting starts and stops at 1.2 m [4 ft] depth.
- Surface time: 0 to 99 h 59 min.
- Dive counter: 0 to 99 for repetitive dives.
- No-decompression time: 0 to 199 min (- - - after 199).
- Ascent time: 0 to 99 min (- - after 99).
- Ceiling depths: 3 to 99 m or 10 to 99 ft (- - after 99 m/ft).

### Displays only in EAN mode:

- Oxygen%: 21 - 50.
- Oxygen partial pressure
- Oxygen Limit Fraction: 1 - 100% (bar graph).

## Logbook/Dive Profile Memory:

- Recording interval in Air/EAN modes: 20 seconds (the recording interval can be set to 10s, 30s or 60s with the optional Suunto PC-interface unit and Suunto Dive Manager software), records the maximum depth of each interval.
- Recording interval in Free/Gauge modes: 2, 4 (default), 10, 20, 30, 60 seconds (user adjustable)
- Memory capacity:

Recording interval	2s	4s	10s	20s	30s	60s
Approx. 45 min. dives	4h	8h	20h	36h	50h	80h
Approx. 1 min. freedives	2h	3h				

- Depth accuracy: 0.3 m [1 ft].
- Dive time accuracy: recording interval.

## Operating Conditions

- Normal altitude range: 0 to 3000 m [10000 ft] above sea level.
- Operating temperature: 0°C to 40°C [32°F to 104°F].
- Storage temperature: -20°C to +50°C [-4°F to +122°F].

It is recommended that the Stinger be stored in a dry place at room temperature.



## Tissue Calculation Model

- Suunto RGBM algorithm (developed by SUUNTO and Bruce R. Wienke, BS, MS and PhD).
- 9 tissue compartments.
- Tissue compartment halftimes: 2.5, 5, 10, 20, 40, 80, 120, 240 and 480 minutes (on gassing). The off gassing halftimes are slowed down.
- Reduced gradient (variable) "M" values based on diving habit and dive violations. The "M" values are tracked up to 100 hours after a dive.
- The EAN and oxygen exposure calculations are based on recommendations by R.W. Hamilton, PhD and currently accepted exposure time limit tables and principles.

## Battery

- One 3 V lithium battery; CR 2430
- Battery storage time (shelf life): Up to two years.
- Replacement: Every two years or more often depending on dive activity.
- Life expectancy at 20°C [68°F]:
  - 0 dives/y           -> 24 months
  - 100 dives/y       -> 12 months
  - 300 dives/y       -> 6 months

The following conditions have an affect on the expected battery lifetime:

- The length and type of the dives.
- The condition in which the unit is operated and stored (e.g. temperature/ cold conditions). Below 10°C [50°F] the expected battery lifetime may be 50-75% of that at 20°C [68°F].
- The use of the backlight and audible alarms.
- The quality of the battery (some lithium batteries may exhaust unexpectedly, which cannot be tested in advance).
- The time the dive computer has been stored until it gets to the customer. The battery is installed into the unit at the factory.

**NOTE:** Low temperature or an internal oxidation of the battery may cause the battery warning to operate even though the battery has enough capacity. In this case, the warning usually disappears when the Dive Mode is activated again.

## 8. WARRANTY

**NOTE:** The warranty arrangements vary in different countries. The dive computer packaging contains information regarding the warranty benefits and requirements applicable to your purchase.

This Suunto dive computer is warranted against defects in workmanship and materials for a period of two years after purchase to the original owner subject to and in accordance with the terms and conditions set forth below:

The dive computer should be serviced or repaired only by an authorized Suunto dealer or distributor.

This warranty does not cover damage to the product resulting from improper usage, improper maintenance, neglect of care, alteration or unauthorized repair. This warranty will automatically become void if proper preventive maintenance procedures have not been followed as outlined in the use and care instructions for this product.

If a claim under this or any other warranty appears to be necessary, return the product, freight prepaid, to your Suunto dealer or distributor or qualified repair facility. Include your name and address, proof of purchase and/or service registration card, as required in your country. The claim will be honored and the product repaired or replaced at no charge and returned in what your Suunto dealer or distributor determines a reasonable amount of time, provided all necessary parts are in stock. All repairs made, not covered under the terms of this warranty, will be made at the owner's expense. This warranty is non-transferable from the original owner.

All implied warranties, including but not limited to the implied warranties of merchantability and fitness for a particular purpose, are limited from date of purchase and in scope to the warranties expressed herein. Suunto shall not be liable for loss of use of the product or other incidental or consequential costs, expenses or damage incurred by the purchase. All warranties not stated herein are expressly disclaimed.

Some states do not allow the exclusion or limitation of implied warranties of consequential damages, so the above exclusions or limitations may not apply to you. This warranty gives you specific legal rights, and you may also have other rights that vary from state to state.

This warranty does not cover any representation or warranty made by dealers or representatives beyond the provisions of this warranty. No dealer or representation is authorized to make any modifications to this warranty or to make any additional warranty.

Battery replacement is not covered by this warranty.

This Instruction Manual should be kept with your dive computer.

## 9. GLOSSARY

Altitude dive	A dive made at an elevation greater than 300 m [1000 ft] above sea level.
Apnea	Absence of breathing. Freedivers are apneic throughout the duration of their dive.
Ascent rate	The speed at which the diver ascends toward the surface.
ASC RATE	Abbreviation for ascent rate.
Ascent time	The minimum amount of time needed to reach the surface on a decompression stop dive.
ASC TIME	Abbreviation for ascent time.
Ceiling	On a decompression stop dive the shallowest depth to which a diver may ascend
Ceiling Zone	On a decompression stop dive the zone between the ceiling and the ceiling plus 1.8 m [6 ft]. This depth range is displayed with the two arrows pointing toward each other (the "hour glass" icon).
CNS	Abbreviation for Central Nervous System toxicity.

## Central Nervous System Toxicity

	Toxicity caused by oxygen. Can cause a variety of neurological symptoms. The most important of which is an epileptic-like convulsion which can cause a diver to drown.
CNS%	Central Nervous System toxicity limit fraction. See note "Oxygen Limit Fraction".
Compartment	See "Tissue group".
DAN	Divers Alert Network.
DCI	Abbreviation for decompression illness.
Decompression	Time spent at a decompression stop or range before surfacing, to allow absorbed nitrogen to escape naturally from tissues.
Decompression range	On a decompression stop dive the depth range, between the floor and ceiling, within which a diver must stop for some time before surfacing.
Decompression illness	Any of a variety of maladies resulting either directly or indirectly from the formation of nitrogen bubbles in tissues or body fluids, as a result of inadequately controlled decompression. Commonly called "bends" or "DCI".
Dive series	A group of repetitive dives between which the dive computer indicates some nitrogen loading is present. When nitrogen loading reaches zero the dive computer deactivates.

Dive time	Elapsed time between leaving the surface to descend, and returning to the surface at the end of a dive.
EAD	Abbreviation for equivalent air depth.
EAN	Abbreviation for enriched air nitrox.
Enriched Air Nitrox	Also called Nitrox or Enriched Air = EANx. Air that has some oxygen added. Standard mixes are EAN32 (NOAA Nitrox I = NN I) and EAN36 (NOAA Nitrox II = NN II).
Equivalent Air Depth	Nitrogen partial pressure equivalent table.
Floor	The deepest depth during a decompression stop dive at which decompression takes place.
Freediver	A breath-holding diver whose only source of oxygen are his lungs filled with surface air.
Half-time	After a change in ambient pressure, the amount of time required for the partial pressure of nitrogen in a theoretical compartment to go half-way from its previous value to saturation at the new ambient pressure.
Hypercapnia	Increased amount of carbon dioxide in the blood. A diver who does not rest adequately between breath-hold dives will have elevated carbon dioxide levels. This can predispose him to carbon dioxide toxicity or blackout.

Hyperventilation	An increase in rate and/or volume of breathing. Carbon dioxide blood levels decrease with little corresponding increase in oxygen blood levels. If the diver engages in excessive hyperventilation, he may diminish his desire to breathe, long enough to become unconscious after a long period of apnea.
Hypoxia	A condition that occurs when a diver's tissues do not receive enough oxygen. Freedivers become hypoxic when they hold their breath; they can eventually suffer blackout if they hold their breath too long.
Multi-level dive	A dive that includes time spent at various depths and whose no-decompression limits are therefore not determined solely by the maximum depth attained.
NITROX	In sports diving refers to any mix with a higher fraction of oxygen than standard air.
NOAA	United States National Oceanic and Atmospheric Administration.
No-decompression time	The maximum amount of time a diver may remain at a particular depth without having to make decompression stops during the subsequent ascent.



## No-decompression dive

Any dive which permits a direct, uninterrupted ascent to the surface at any time.

NO DEC TIME      Abbreviation for no-decompression time limit.

OEA = EAN = EANx      Abbreviation for Oxygen Enriched Air Nitrox.

OLF      Abbreviation for Oxygen Limit Fraction.

OTU      Abbreviation for Oxygen Tolerance Unit.

## Oxygen Tolerance Unit

Is used to measure the Whole-Body-Toxicity.

## Oxygen Limit Fraction

A term used by SUUNTO for the values displayed in the Oxygen Toxicity bar graph. The value is either the CNS% or the OTU%.

O<sub>2</sub>%      Oxygen percentage or oxygen fraction in the breathing gas. Standard air has 21% oxygen.

## Oxygen partial pressure

Limits the maximum depth to which the used Nitrox mixture can safely be used. The maximum partial pressure limit for enriched air diving is 1.4 bar. The contingency partial pressure limit is 1.6 bar. Dives beyond this limit have the risk for immediate oxygen toxicity.

PO<sub>2</sub>

Abbreviation for oxygen partial pressure.

Suunto RGBM

Abbreviation for Suunto Reduced Gradient Bubble Model.

Suunto Reduced Gradient Bubble Model

Modern algorithm for tracking both dissolved and free gas in divers.

Repetitive dive

Any dive whose decompression time limits are affected by residual nitrogen absorbed during previous dives.

Residual nitrogen

The amount of excess nitrogen remaining in a diver after one or more dives.

Shallow - water blackout (SWB)

An unconscious state divers experience when the brain becomes deprived of oxygen. SWB frequently happens without warning, causing death by subsequent drowning.

Static apnea blackout	Unconsciousness due to gradual oxygen depletion caused by holding one's breath too long. It can occur anywhere, particularly at the surface, and is not associated with depth or pressure changes. It commonly occurs in swimming pools at the surface or during long underwater endurance swims.
SURF TIME	Abbreviation for surface interval time.
Surface interval time	Elapsed time between surfacing from a dive and beginning a descent for the subsequent repetitive dive.
Tissue group	Theoretical concept used to model bodily tissues for the construction of decompression tables or calculations.
Whole-Body Toxicity	Another form of oxygen toxicity, which is caused by prolonged exposure to high oxygen partial pressures. The most common symptoms are irritation in the lungs, a burning sensation in the chest, coughing and reduction of the vital capacity. Also called Pulmonary Oxygen Toxicity. See also OTU.

## DISPOSAL OF THE DEVICE

Please dispose of the device in an appropriate way, treating it as electronic waste. Do not throw it in the garbage. If you wish, you may return the device to your nearest Suunto dealer.



## COPYRIGHT

This publication and its contents are proprietary to Suunto Oy.

Suunto, Wristop Computer, Suunto Stinger, Replacing Luck and their logos are registered or unregistered trademarks of Suunto Oy. All rights reserved.

While we have taken great care to ensure that information contained in this documentation is both comprehensive and accurate, no warranty of accuracy is expressed or implied. Its content is subject to change at any time without notice.

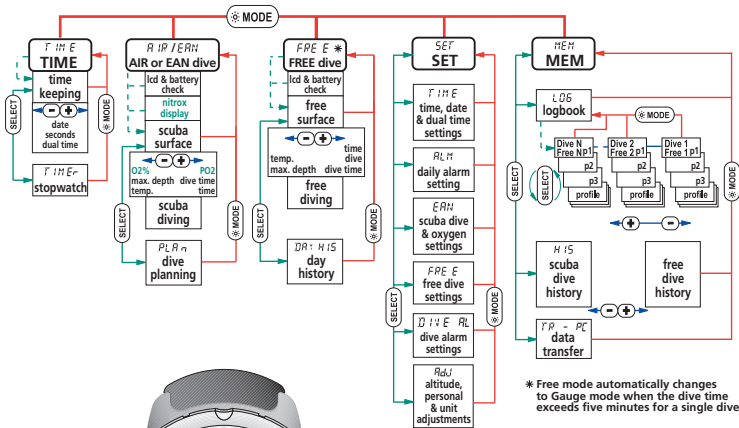

\* Free mode automatically changes to Gauge mode when the dive time exceeds five minutes for a single dive.

**SELECT**

select next

**MODE**

mode light exit

**-**

**+**



## SUUNTO STINGER MODES AND OPERATIONS

**Model of  
Computer:**

_____	_____	_____	_____	_____	_____	_____	_____	_____	_____
_____	_____	_____	_____	_____	_____	_____	_____	_____	_____
_____	_____	_____	_____	_____	_____	_____	_____	_____	_____
_____	_____	_____	_____	_____	_____	_____	_____	_____	_____

**Serial  
number:**

**Date of purchase** \_\_\_\_\_

**Place of purchase/Store name** \_\_\_\_\_

**Store City** \_\_\_\_\_ **Store Country** \_\_\_\_\_

**Store stamp with date of purchase**

--

**Name** \_\_\_\_\_

**Address** \_\_\_\_\_

**City** \_\_\_\_\_ **Country** \_\_\_\_\_

**Telephone** \_\_\_\_\_ **E-mail** \_\_\_\_\_

**Signature** \_\_\_\_\_



# SUUNTO

## TWO YEAR WARRANTY

**This product is warranted to be free of defects in material and/or workmanship to the original owner for the above noted period (does not include battery life). Keep a copy of the original purchase receipt and make sure to get this warranty card stamped at the place of purchase. The warranty originates from the date of purchase.**

**All warranties are limited and are subject to the restrictions given in the instruction manual. This warranty does not cover the damage to the product resulting from improper usage, improper maintenance, neglect of care, alteration, improper battery replacement or unauthorized repair. Suunto's dive computers and wristop computers can be registered online at [www.suunto.com](http://www.suunto.com).**

[www.suunto.com](http://www.suunto.com)

Made in Finland

© Suunto Oy 06 / 2004, 03 / 2006