

**iDIVE SYSTEM**

*Pretendere L' Eccellenza*



# iDive Tech



User manual

Ver: 1.3

# INTRODUCTION

Congratulations on purchasing your Dive System computer.

Dive System, with the quality of its products, has always been at your side to guarantee comfort, enjoyment and safety in diving.

The Dive System computer that you purchased is an extremely modern computer which includes comprehensive software for recreational and technical diving.

The Dive System computer iDive Tech includes a decompression algorithm supportive of air, nitrox and trimix dives, a complete algorithm integrates decompression and its processor calculates in real time the specific dive profile of your dive, for the benefit of flexibility and safety



Check the [www.divesystem.com](http://www.divesystem.com) website for any updates to the manual.

# TABLE OF CONTENTS

<b>Introduction</b>	<b>2</b>	<b>Settings</b>	<b>28</b>
<b>Table of Contents</b>	<b>3</b>	Dive set	30
<b>Cautions</b>	<b>5</b>	<i>P. Safety - Security Level</i>	30
<i>General instructions</i>	5	<i>Safety Stop</i>	32
<i>Danger warnings</i>	7	<i>Deep stop</i>	33
<i>Nitrox Diving</i>	9	<i>Max P<sub>p</sub>O<sub>2</sub></i>	34
<i>Before a dive</i>	10	<i>Salt and Fresh water</i>	35
<i>Limits of the dive computer</i>	11	Mix	36
<i>Care and Maintenance</i>	11	<i>Mix 1</i>	36
<b>Specifications</b>	<b>13</b>	<i>Mix 2 - 3 - 4 - 5 - 6 - 7 - 8</i>	37
<b>Menus and Functions</b>	<b>18</b>	Planner	39
Backlight	19	Logbook	41
Battery level	19	Alarm	43
Information	19	<i>ASC Speed</i>	43
Compass	20	<i>Max Depth</i>	44
Weather	22	<i>Deco Viol</i>	44
Atmospheric press., altim. and temp.	23	Display	45
Clock	25	<i>BKL Level</i>	45
Dive	25	<i>BKL Time</i>	46
Gauge	26	<i>Contrast</i>	46
Free Dive	27	<i>Units</i>	47
		PC Mode	48

## Sommario

Sys Set _____	49	iDive after immersion _____	64
<i>UTC - Time zone</i> _____	49	No-Fly _____	64
<i>Time</i> _____	50	<b>iDive in Gauge</b> _____	<b>65</b>
<i>Format</i> _____	50	Gauge _____	65
<i>Date</i> _____	51	<b>iDive in Free</b> _____	<b>67</b>
Default _____	52	Free mode during dive _____	67
Compass _____	53	Free mode on the surface _____	67
<i>Declin</i> _____	53	<b>Troubleshooting</b> _____	<b>68</b>
<i>Dir</i> _____	54		
<i>Calib</i> _____	54		
<b>iDive during diving</b> _____	<b>56</b>		
Dive _____	57		
NDL _____	58		
CNS and temperature _____	57		
Dive profile _____	57		
Extra Safety Stop _____	58		
Deep Stop _____	59		
Deco dive _____	60		
Dive compass _____	61		
Switch gas during dive _____	62		
<b>iDive - the data on the surface</b> _____	<b>63</b>		

# CAUTIONS

## ***General instructions***

This User's Guide contains certain hazards and should be carefully read.

- It is essential to read this user manual before using the Dive System computer. The incorrect use of the computer or its accessories will void the warranty and may cause permanent damage to the computer itself and / or its accessories.
- The dive computer is NOT A SUBSTITUTE to scuba diving training and should be used only by divers who have been properly trained
- The Dive System computer is an auxiliary tool to diving, therefore it is mandatory to always have an adequate table in order to perform the decompression phase in the case of malfunction to the unit
- Diving carries risks related to decompression sickness, oxygen toxicity and other inherent risk and even careful perusal of this manual and use of this instrument does not rule out potential dangers. Anyone who does not understand or does not knowingly accept these risks should not dive with the iDive computer.
- Diving has some inherent risks that can never be completely excluded. No dive table or computer can ever ensure that there are no Decompression Illness risk (DCI) or Central Nervous System

## Cautions

Oxygen Toxicity even if the diver scrupulously and correctly follows the instructions of dive tables or computers.

- The computer is not able to take into account individual physiological variations that can alter day to day and for this reason it is good practice to use this instrument in a conservative and precautionary manner, remain well within the limits set by the computer in order to minimize the risk of decompression sickness and oxygen toxicity to the central nervous system.
- The computer does not replace decompression training of tables that you always want to have as a backup together with a depth gauge and watch.
- It is prohibited to share a single computer for two divers while diving, each diver must carry their own instrument which provides information only to them.
- It is prohibited to dive with a computer that did not take into account previous dives made by the diver, its calculation can never take into account data that it does not know.
- Personal Safety factors: carefully read the detailed instructions on how to set up and choose the appropriate level. The 0 to 3 value scale provides a higher level of conservatism with the increase of its value.

### ***Danger warnings***

- The computer is NOT intended for PROFESSIONAL use! The computer is intended for sports use only.
- Non compliance to the above may expose the diver to an increased risk of incurring decompression illness (DCI) It is therefore not recommended for commercial or professional diving.
- Before diving you must check the battery level, DO NOT dive with the battery level of 30% or lower, check that the display does not show any sign of malfunction and that it is legible.
- Check that the settings correspond to those desired.

## Cautions

- Keep in mind that our body has daily variations of which the computer cannot take into account.
- You must avoid all behavior that increase risks associated with decompression sickness such as rapid ascents, yo-yo diving, decompression stop obligations, dives with surface intervals too close together and by any other behavior not dictated by common sense and training.
- However the use of the instrument, does not allow its use without due preparation through specific training. Failure to follow the basic rules of diving exposes the diver to life threatening circumstances. We recommend diving within the safety curve in order to reduce risks associated with decompression sickness.
- We recommend not exceeding 40 meters diving or based on the oxygen % value within the cylinder, max 1.4 BAR PpO<sub>2</sub>. Exposure to higher values exposes the diver to life-threatening conditions.
- We do not recommend diving with Mandatory Safety Stops.
- Comply with the ascent rate recommended by the instrument, an excessive ascent rate exposes the diver to life threatening conditions.
- The computer calculates the total time of ascent but may be longer than that displayed according to certain parameters that the computer recalculates throughout the dive, try to use the correct ascent



## Cautions

speed, observing the depth stops displayed helps meet this duration.

- No FLY Time: it is prohibited to board a plane if the NO FLY TIME icon on the display is still on. Remember to plan the last dive of the series taking into account the recommendations provided by DAN (Divers Alert Network).
- Even if you meet all the set intervals, we cannot exclude the onset of decompression disease while flying after diving.

### **Gas mix**

- Setting the oxygen fraction contained in a cylinder the computer will only take into account whole numbers such as when 32.8 percentage of oxygen is used, a whole number value that is less than 32 should be set. Do not round to a top number as this will underestimate calculations relating to the nitrogen.
- Check the PpO<sub>2</sub> max settings and never exceed the 1.4 BAR value.
- DO NOT DIVE without checking the contents of the cylinder with declared reliable instruments. Check the gas settings on the computer to match those contained in the cylinder with which you will dive with.

## *Cautions*

- Diving with Nitrox requires specific training, DO NOT dive without due training. Exceeding the maximum PpO<sub>2</sub> settings and those recommended imposes an immediate ascent to a lower level and in the event of a CNS value (Central Nervous System) approaches the recommended limits we advise a reduction of oxygen exposure.

### ***Before a dive***

- Use the dive computer only after reading the instruction manual in its entirety and you thoroughly understand its operation. In cases of doubt or questions, please contact your dealer before diving.
- It is important to understand that every diver is totally responsible for their own safety.
- Diving with gas mixtures involves different risks from those associated with standard air diving. You need proper training to learn how to understand and avoid such risks, which are not readily ascertainable. These risks include possible serious injury or death.

### ***Limits of the dive computer***

- The computer reflects the latest guidelines on diving safety but keep in mind that these studies are to be considered of theoretical basis and processed to reduce but not eliminate the risk of decompression sickness.

### ***Care and Maintenance***

- Keep your computer clean and dry. Do not expose the computer to chemicals, including alcohol. To clean the computer use only fresh water to remove all saline deposits. Leave the computer to dry naturally, do not use jets of hot or cold air.
- Do not expose the computer to direct sunlight or sources of heat above 50 ° C. Keep your computer in a cool and dry place (5°C - 25°C).
- Do not attempt to open, modify or repair the computer on your own. Always contact the manufacturer through an authorized service provider.
- Do not put the computer into a hyperbaric chamber.
- The computer is designed for accuracy in the readings of +/- 2%. European rules require that the

## Cautions

unit is controlled periodically from the point of view of accuracy in reading, the depth and time. The level of precision required by European standards is +/- 3.5%.

- The warranty is voided if the endcap is removed from a non-authorized service center.
- The computer iDive is built to withstand use in sea water but at the end of the dive you have to rinse well with fresh water and do not expose to direct sunlight or heat sources to dry.
- Check the display there are no traces of moisture on the inside.

***Note: Do not groped to open the computer for any reason in case of problems contact your service through the retailer where it was purchased.***

## SPECIFICATIONS

Your computer is made in all stainless steel 316L with sapphire glass, allowing in this so a high impact resistance and corrosion resistance.

Display is equipped with an LCD Display 100% matrix.

Particular effort has been put in the development of a navigation system that allows the diver access to the settings in an easy and intuitive.

- **Certifications:** The computer hardware has received CE and EN13319.

- **Warranty sensor accuracy:** 130 m.

- **Maximum depth:** 220 m.

- **Accuracy of Measuring Absolute Pressure**

	min	max	
p = 0 .. 5bar	-20	+20	mbar
p = 0 .. 10bar	-40	+20	mbar
p = 0 .. 14bar	-100	+20	mbar

## Specifications

- **Maximum error in the measurement of temperature:** -2 / +6°C

### - **Algorithm**

The computer adopts the model Buehlmann ZHL-16B and offers a choice of 4 levels of conservatism

0	Values of Gradient Factor High 93- Gradient Factor Low 93
1	Values of Gradient Factor High 85- Gradient Factor Low 75
2	Values of Gradient Factor High 80- Gradient Factor Low 70
3	Values of Gradient Factor High 75- Gradient Factor Low 50

- **ASM: Adaptive Sigmoidal Model:** Optimizes the decompression calculations for repetitive dives.

- **Extra Deep Stops:** The computer provides the opportunity to enter the Extra Deep Stops

- **Control of violation:** Monitoring the behavior during the ascent of the diver, and puts out the computer function if, and only if, the decompression algorithm is no longer valid.

## Specifications

- *Automatic check and adaptation to altitude.*
- *Update tissue dive mode: 5 seconds.*
- *Update tissues sleep mode: 1 minute.*
- *Number of stored gas OC: 8.*
- *Memory: 100 hours of immersion.*
- *100 hours of immersion. 1999 min.*
- *Intuitive software for adaptive logic.*
- *Connection to PC: USB cable*
- *Operating System (OS) Updatable.*

### - **Battery**

It has a rechargeable battery with an autonomy of 25 days in clock mode, or 30 hours of diving. Perform a full charge cycle before the first use.

The charge is made by connecting the computer via its USB cable to the PC or to a any USB port. The data shown may vary by +/-15%.

### **Warning: Do not dive when the computer marks the 30% charge or lower**

The battery life depends on the applications installed and the version of the operating system. By connecting the USB cable for charging appears within 45 seconds, the symbol (arrow) in charge of the course in screen clock.

The charge is complete when the battery symbol disappears from the screen clock.

The data of battery life are related to applications in optimal conditions.

Improper use of the backlight will significantly decrease battery life.

Beware, if you are immersed in particularly cold water battery voltage may drop.

Therefore it is always advisable to recharge the battery before diving in extreme conditions.

It is recommended to always complete the charging cycle.

If a charge cycle is not completed the indicator of battery charge may not be precise.

After installing an APP or update the operating system, it is recommended that a cycle Battery charging complete.



## Specifications

- **Weight:** 140gr
- **100% compatible** with the program of data collection DAN DL7 DSL Level 5



# MENUS AND FUNCTIONS

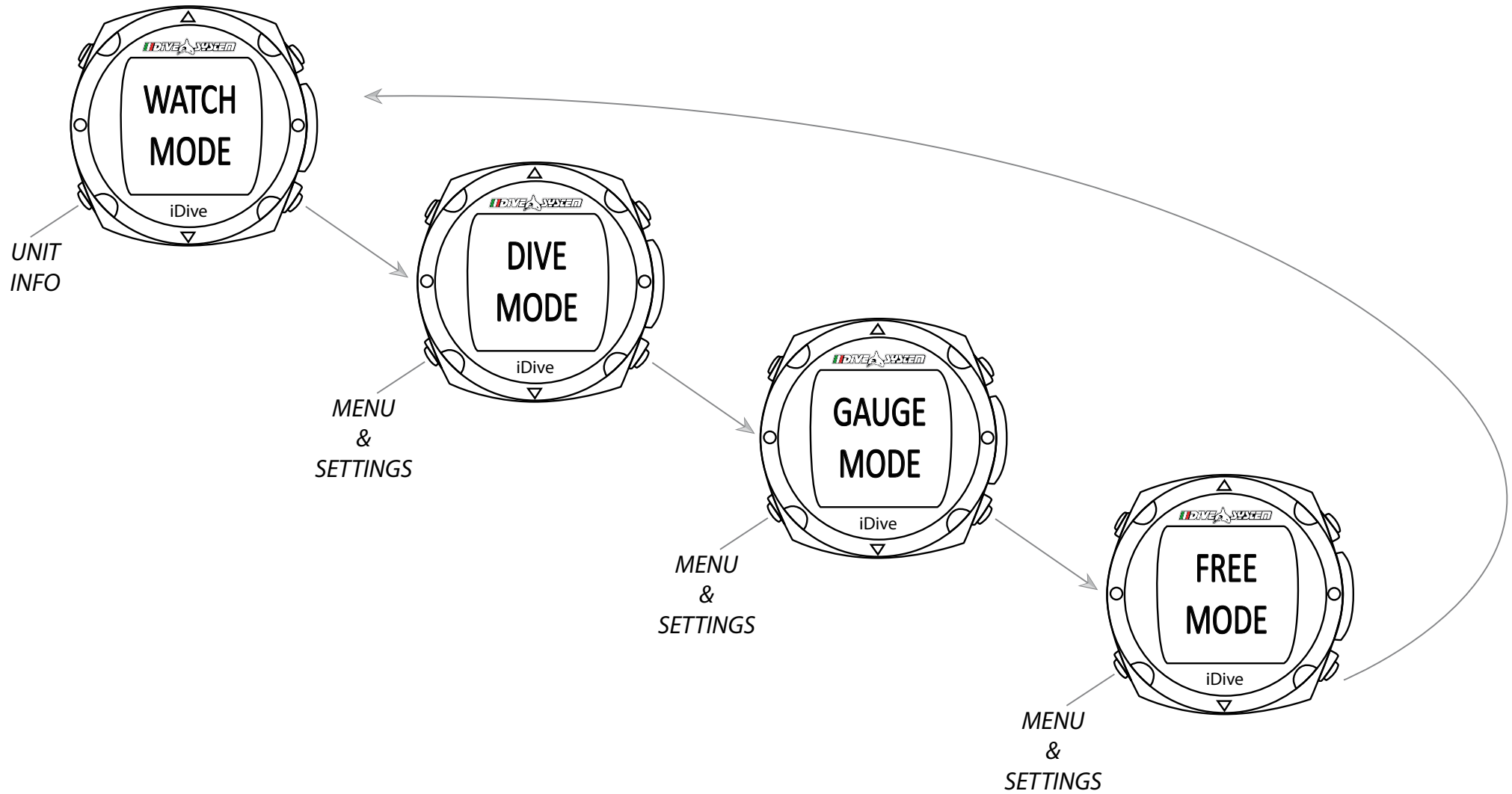

## Menus and Functions

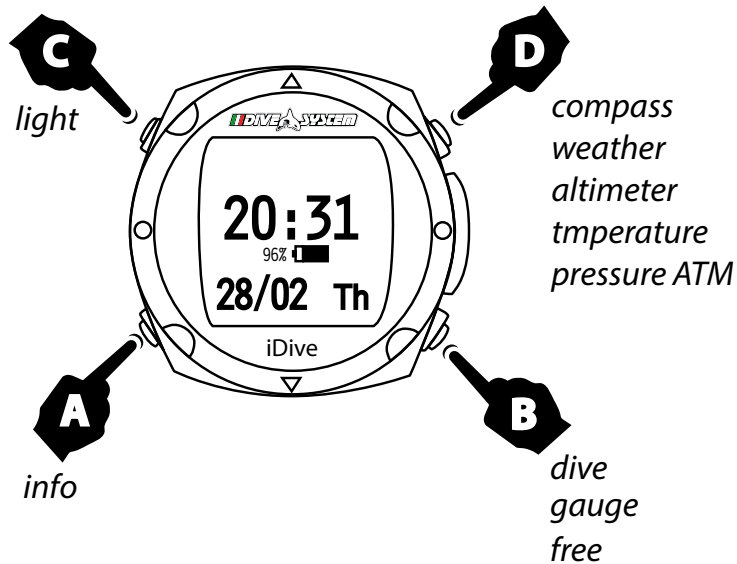

### Backlight

For you activate the backlight, press the **C** key twice.

Its unique backlight gives an accurate view around the display, even in twilight diving.

### Battery level

To view the battery level by pressing any key.

The battery level will be displayed for 30 seconds when the service higher than 30%. To autonomy less than 30% the symbol will remain always in evidence.

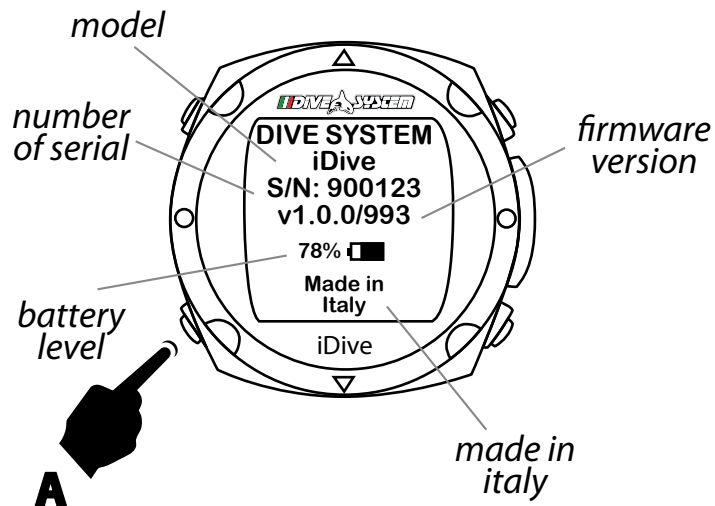

### Information

To view information click once on the button **A** if you are screen battery level.

Press **A** button twice if you watch the screen.

In addition to the serial number of the computer, you can check the version of software installed in your computer.

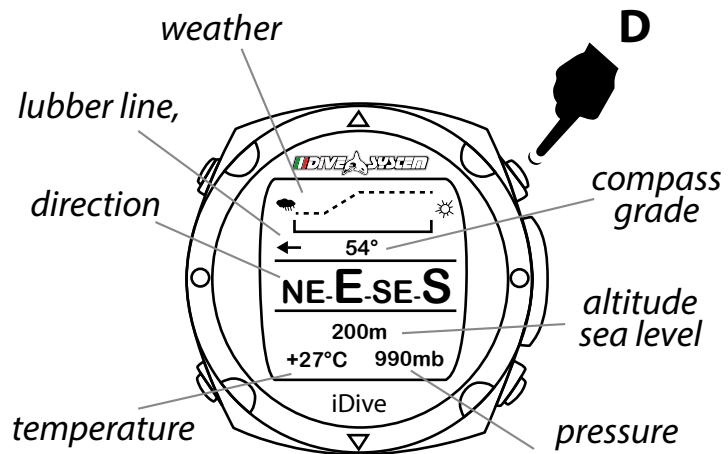

### Compass

To view the compass press once on the **D** if you are in screen battery level.

Turning the clock compass indicates the direction in front of us.

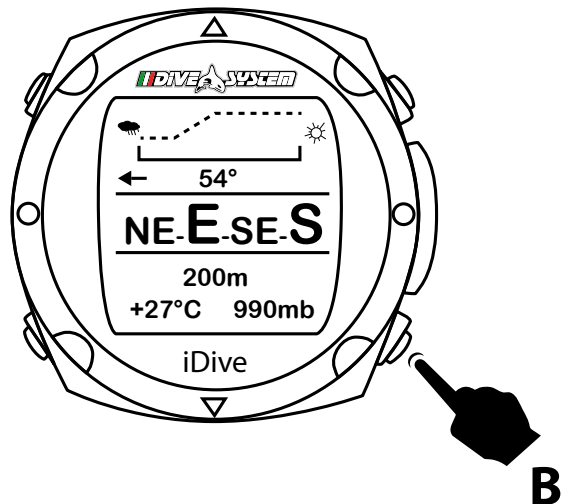

To set a route, press **B**.

So that the direction is within  $\pm 5^\circ$  from the set course is shown the value of the direction.

If you move from the set course for an angle greater than  $\pm 5^\circ$  will show an arrow that indicates the direction to follow to get back in the set course.

The electronic compass is able to correct the direction indicated for a tilt angle up to  $85^\circ$ .

The larger the tilt decreases the accuracy of the instrument up to a maximum of  $\pm 5^\circ$ .

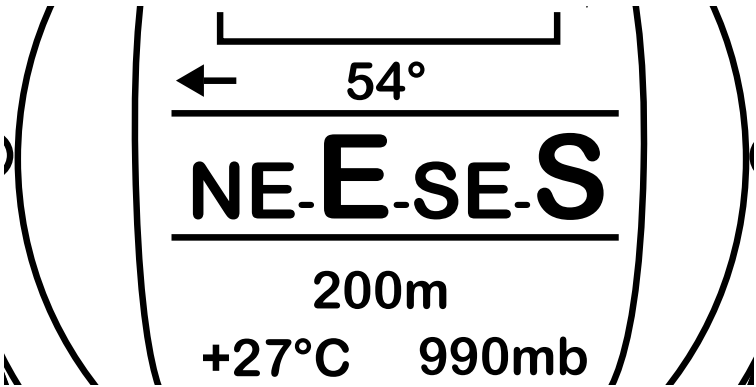

The table below shows the meaning of each of the short for direction on the display:

Direction	Meaning	Direction	Meaning
N	North	NE	Northeast
E	East	SE	Southeast
S	South	SW	Southwest
W	West	NW	Northwest

**Weather**

iDive also shows you the weather forecast.

To view the weather forecast press once on the INFO button if you are in screen battery level.

The next table shows how to interpret the weather forecast of the iDive

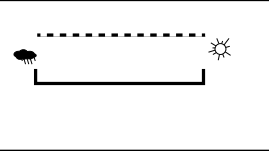
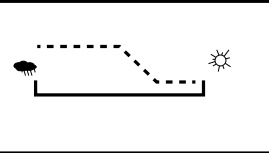
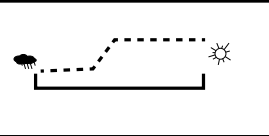
	<p><i>stable</i></p>
	<p><i>worsening</i></p>
	<p><i>improvement in</i></p>

The weather forecast is based on the monitoring of atmospheric pressure in the previous 18 hours. To get a reliable weather forecast you must not make changes in elevation, otherwise the change atmospheric

pressure due to the change in altitude may introduce inaccuracies in forecasting weather.

Attention: after the dive due to moisture present in the area of the pressure sensor actually accessed could be lower than the actual one, which could compromise a correct weather forecast.

After a change in proportion of ca. The weather will be back 50m valid after 3/5 hours.

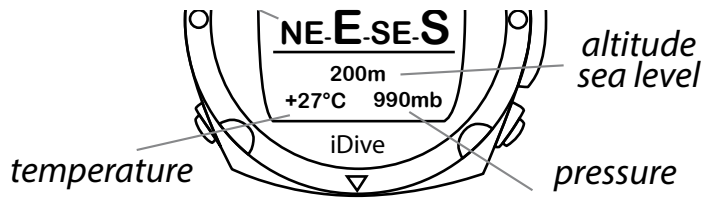

### Atmospheric pressure, altimeter and temperature

To view information about atmospheric pressure, altimeter and temperature press the INFO button once if you are in the screen battery level.

Atmospheric pressure is the pressure at any point the Earth's atmosphere. It is measured in millibars (mbar)

**Warning: after a dive due to moisture present in the headquarters of the pressure sensor read may be slightly lower than the real.**

The value of the height above sea level is calculated based on the barometric pressure.

**Warning: the precision of the measurement depends on the altitude directly from atmospheric pressure or moisture in the home of the sensor. So in the event of bad weather, the error may be up to +/-80m.**

iDive measured temperature is the temperature of the watch case itself. So when wearing the wrist will measure a temperature higher than the outside. To measure the temperature environment, remove the watch from your wrist and wait at least 5 minutes.

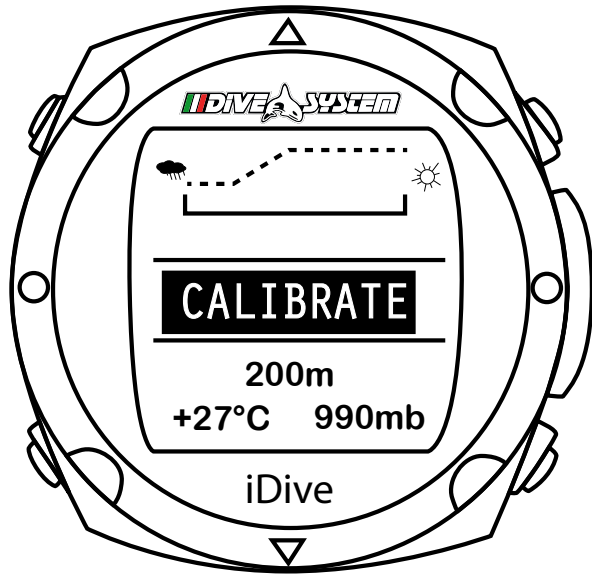

Through the function in the DISPLAY menu you can change the unit in °C or °F.

When instead of the indications of the compass appears CALIBRATE you have to re-calibrate the compass.

You can calibrate the compass by following the instructions that you find in the section "Compass".



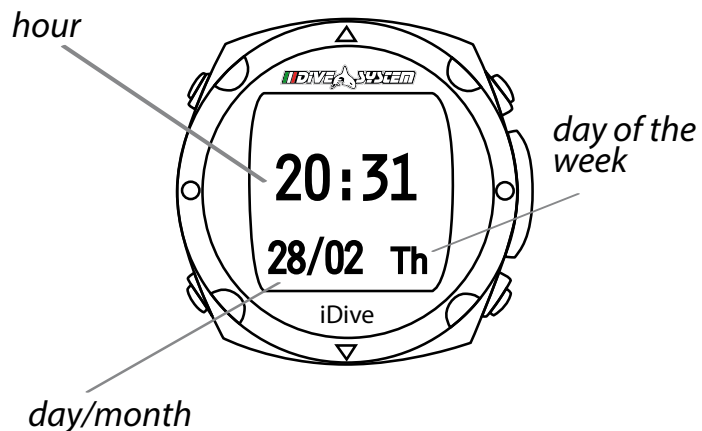

### Clock

The computer area has the functions of a clock with hour, minute, day, month, and day of the week.

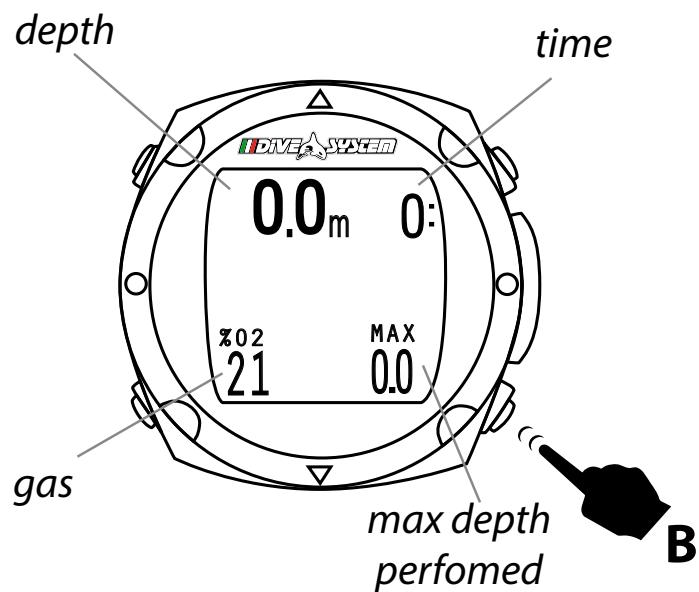

### Dive

To activate the Dive to dive you have to press the **B** button twice.

Once you enable this feature you can dive using air, programmed for nitrox mixtures or your dive.

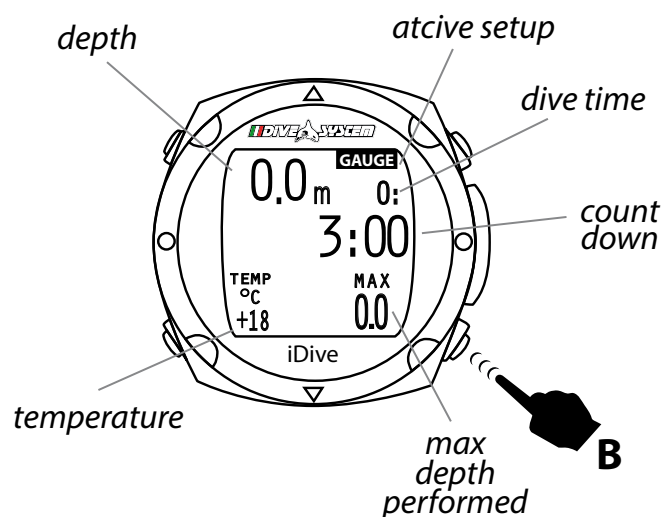

### Gauge

To activate the Gauge to immerse you have to press the **B** button 3 times. This function remains active for 15 minutes after the time clock screen appears.

With this function you can immerse yourself in using your clock as a depth gauge.

**CAUTION: If you do not set the beginning of the dive GAUGE mode the clock starts DIVE function. After using the depth gauge the computer is not blocked.**

**So you can use the dive computer in the immersion next, since during the use of the depth gauge the computer has calculated the saturation of the tissues with a mixture fictitious high content of inert.**

**Due to the use of the mixture for the fictitious calculations during the calculation of the gauge mode decompression profile in the immersion of the next (max 48 hours) in computer mode be more conservative.**

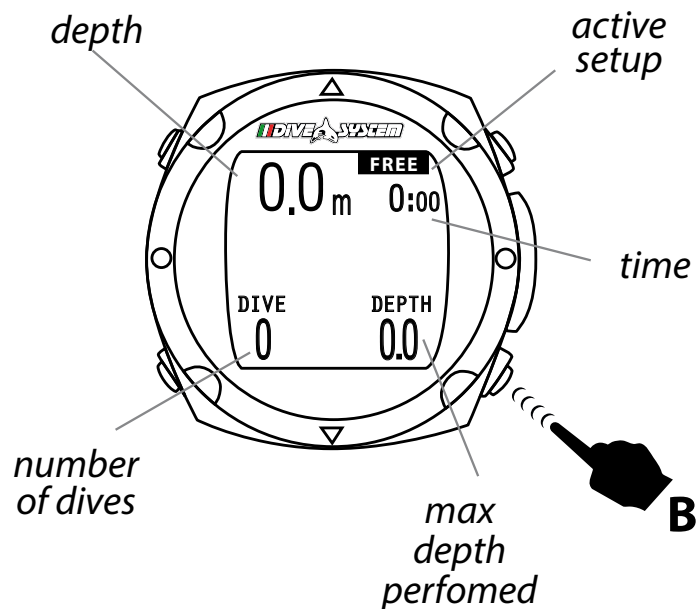

### Free Dive

To activate the Free Dive to immerse you must press the **B** button 4 times.

This function remains active for 15 minutes after the time appears.

**WARNING: If you do not set any function at the beginning dive the clock starts running DIVE.**

**After a dip in FREE DIVE mode is not available or selectable.**

## SETTINGS

The computer comes standard with settings that allow for recreational diving, then dive up to 40 meters, within the no-decompression limits and without the use of gas decompression, without having to modify any parameter of your computer.

If you proceed to make dives that make it necessary switches in decompression gases you will need to set and enable the gas that will be used during the dive..

**Caution: During the dive can be enabled or disabled gas previously entered during the planning, but you can not change their composition during the dive.**

## Settings

iDive menu provides access to functions and settings are changed.

To enter the menu, press the **B** button before entering the *Dive* screen and then press the **A** button

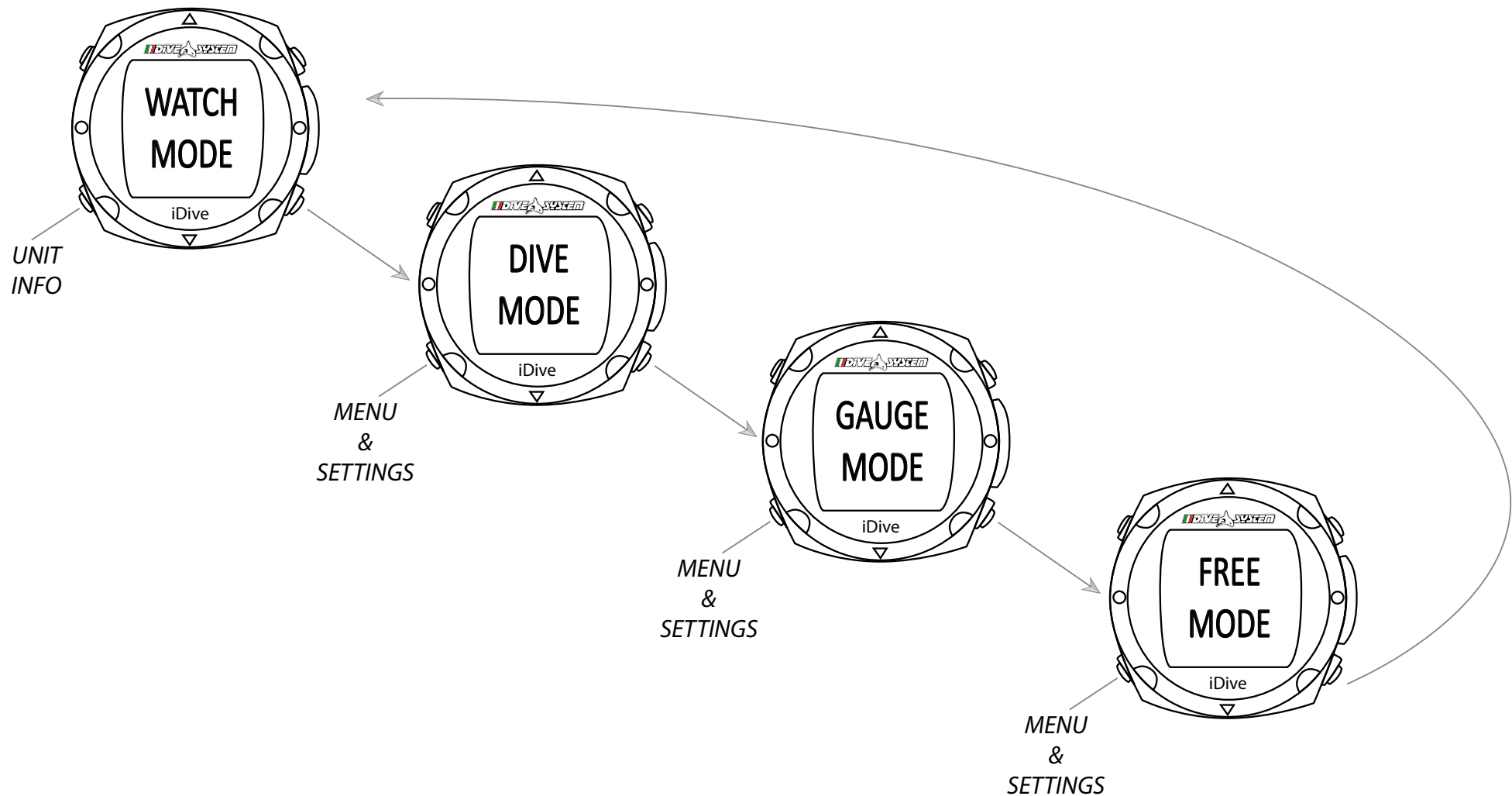



By pressing the **B** or **D** from the main screen menu, you can scroll through the various menu items.

When you see the name of a function you must press the **A** key to access the function.

## Dive set

Pressing **A** will access the function.

In this function you can set the level of security, the dwell time Safety, deep stop function, the max PpO<sub>2</sub> and water.

## P. Safety - Security Level

The computer iDive is equipped with an algorithm, Buehlmann, the algorithm based on the theories of Buehlmann, implemented in iDive a derivative of the model Buehlmann ZHL16B that integrates the results of latest research in the medical-scientific.

Is possible to change the levels of conservatism turning 4 different settings based on the gradient of the factor model Buehlmann ZHL16B.

Press the **B** or **D** to increase or reduce the level of conservatism and then the **A** button to confirm setting.



## Settings

The setting level 0 corresponds to a value of gradient High factor equal to 93 and a value of Gradient factor at least equal to 93.

The setting level 1 corresponds to a value of gradient High factor equal to 85 and a value of Gradient minimum factor of 75.

The setting level 2 corresponds to a value of gradient High factor equal to 80 and a value of Gradient factor at least equal to 70.

The setting level 3 corresponds to a value of gradient High factor equal to 75 and a value of Gradient minimum factor of 50.

0	Values of Gradient Factor High 93- Gradient Factor Low 93
1	Values of Gradient Factor High 85- Gradient Factor Low 75
2	Values of Gradient Factor High 80- Gradient Factor Low 70
3	Values of Gradient Factor High 75- Gradient Factor Low 50

Warning: the control parameters of the conservatism of the algorithms need to be modified only and only if you have appropriate theoretical knowledge.

**Dive System is not responsible for damage to persons or property due to an incorrect setting of these parameters.**



## **Safety Stop**

Setting the timer to the safety stop.

The timer for the safety stop will start automatically when the end of the dive, you will reach a depth less than 6 m are you have performed all decompression stops.

The value can be set between 0 and 5 minutes

Press the **B** or **D** to increase or decrease the minutes and then press **A** to confirm the setting.

To disable the safety stop set this parameter to 0 minutes.





## **Deep stop**

In iDive you can enable or disable the deep stop.

Press the **B** or **D** to set YES or NO and then the **A** button to confirm the setting.

The stop is calculated in the middle of the maximum depth for a time of 2.5 minutes.

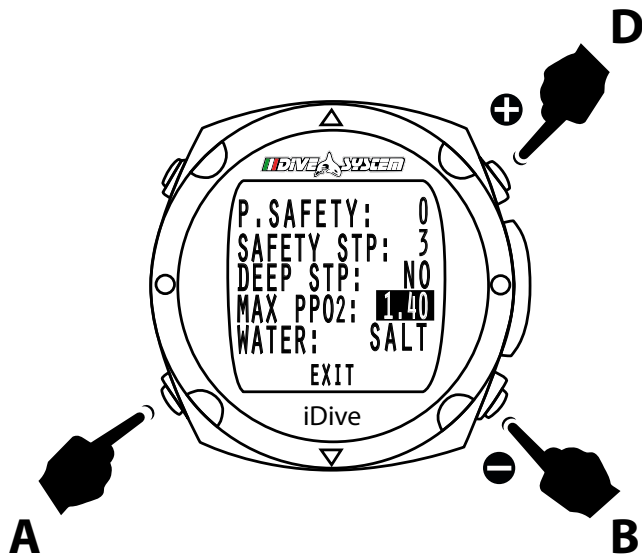

### **Max PpO<sub>2</sub>**

The value of PpO<sub>2</sub> max determines the maximum operating depth (MOD) in relation to the mixture of oxygen used.

Press the **B** or **D** to set increase or decrease the value and then the **A** button to confirm setting.

The PpO<sub>2</sub> max can be set to a value between 0.7 and 1.6 bar.

It is recommended to avoid exposure to oxygen partial pressures higher to 1.3 ATA.

Oxygen toxicity is considered a high risk factor for the life of the diver, the studies about can not guarantee NOT exposure to this danger of oxygen toxicity even at partial pressures less than 1.3 ATA, the diver must know through the proper training this risk factor and consciously accept.

Otherwise must not dive with the computer iDive

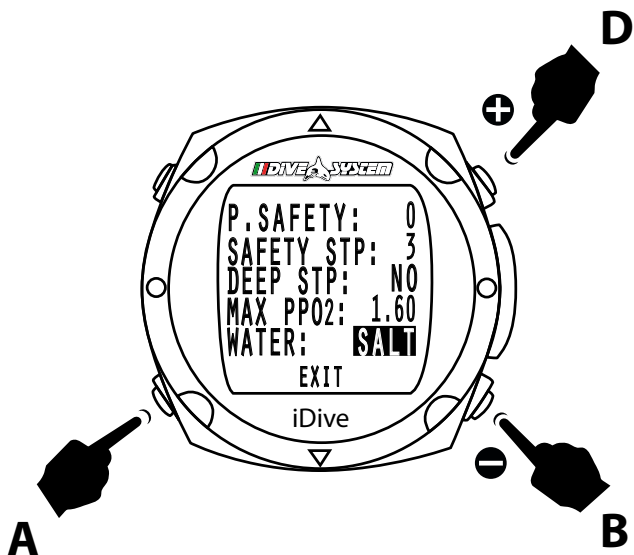

### **Salt and Fresh water**

iDive measure the pressure and converts it into depth using the density water as a constant.

The depth of 10 m in salt water corresponds approximately to 10.3 m in fresh water.

Press the **B** or **D** to set SALT choose to salt water FRESH and for fresh water and then the **A** button to confirm



## Mix

Press **B** or **D** key in order to scroll the various menu items and then the **A** button to confirm the setting.

With iDive you can set more gas mix.

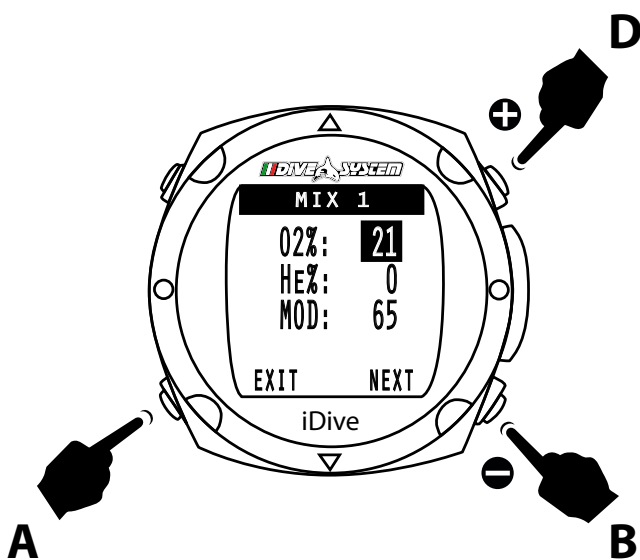

## Mix 1

Press **B** or **D** in order to increase or decrease the percentage of oxygen and **A** to confirm the o2 percentage inserted.

iDive automatically calculate the MOD.

Press **A** in order to move to NEXT and set the Mix 2.

## ATTENTION:

**The dive will start with the Mix 1**

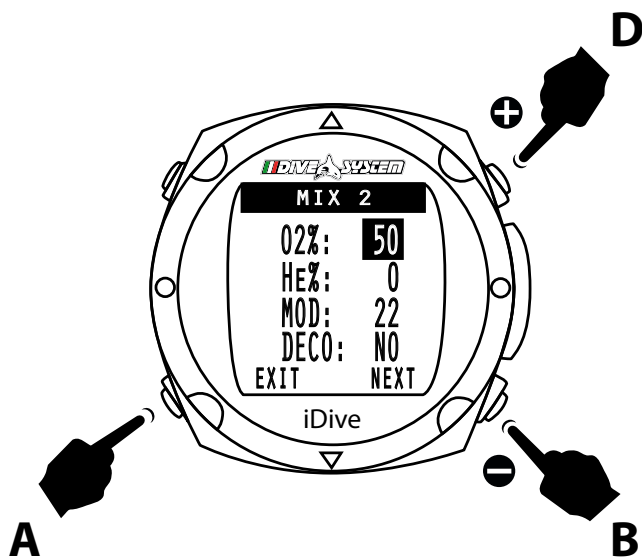

## Mix 2 - 3 - 4 - 5 - 6 - 7 - 8

Press **B** or **D** in order to increase or decrease the percentage of gas and **A** to confirm the percentage inserted and set the next gas.

iDive automatically calculates the MOD.

Select YES if the current mix will be used as a decompressive. Select NO if the current mix will not be used as decompressive.

**CAUTION: After each dive, the MIX1 is automatically set as the mixture in use.**

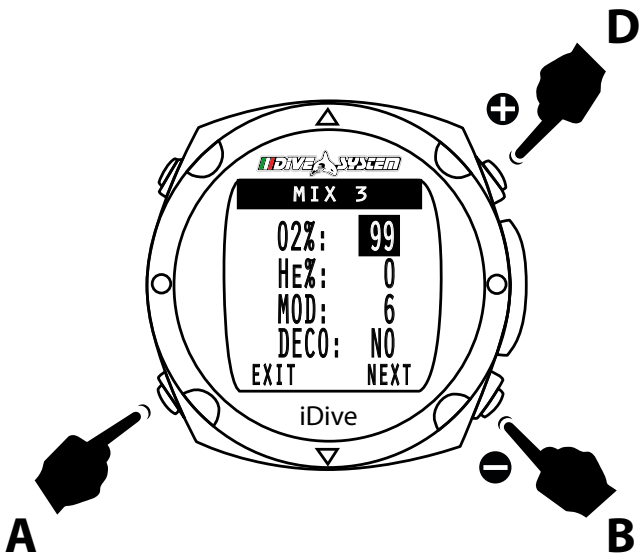



## Planner

Press **B** or **D** in order to scroll through the various menu items and press **A** to set Planner function.

With iDive you can plan your repetitive dives.

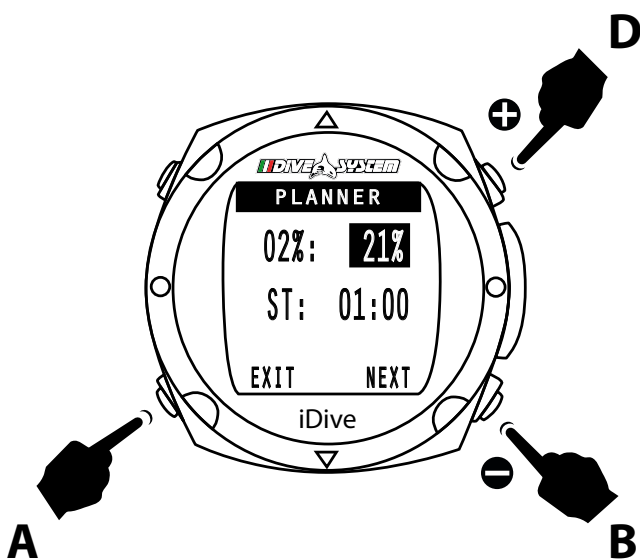

Press **B** or **D** in order to increase or decrease the percentage of oxygen and press **A** to confirm

Press **A** to set the surface time and press **B** or **D** to increase or decrease the surface time.

Press **A** to move on NEXT menu and press **B** to show the table

The maximum depth into the table respects the MOD role.

## Settings

Press **B** to next table .

Press **B** in order to exit form Planner function

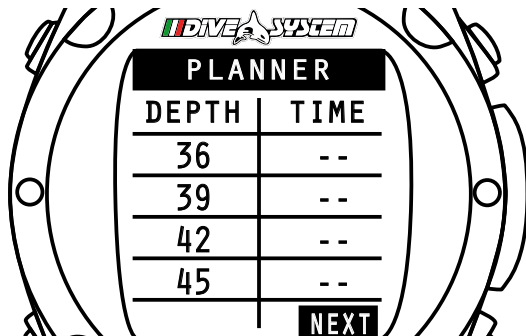
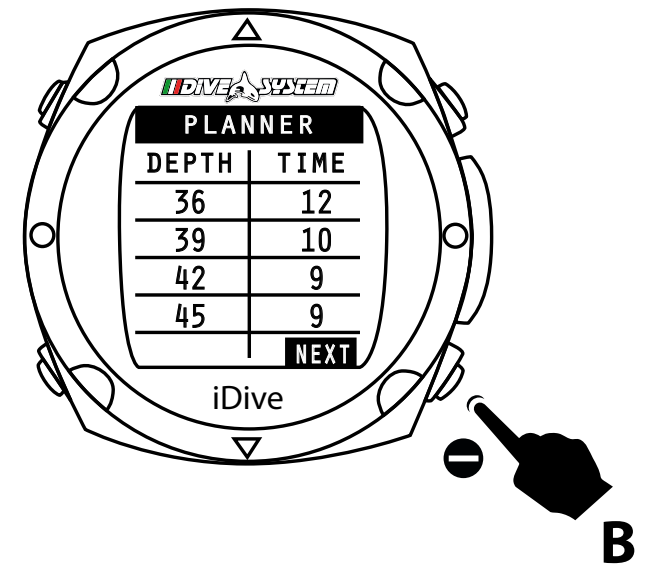
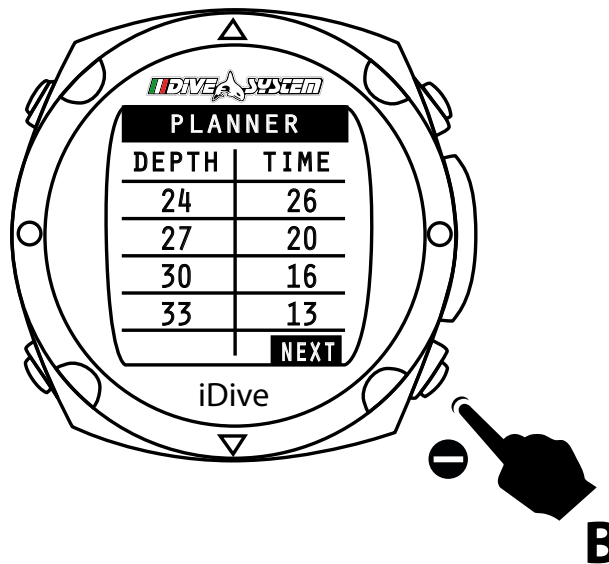
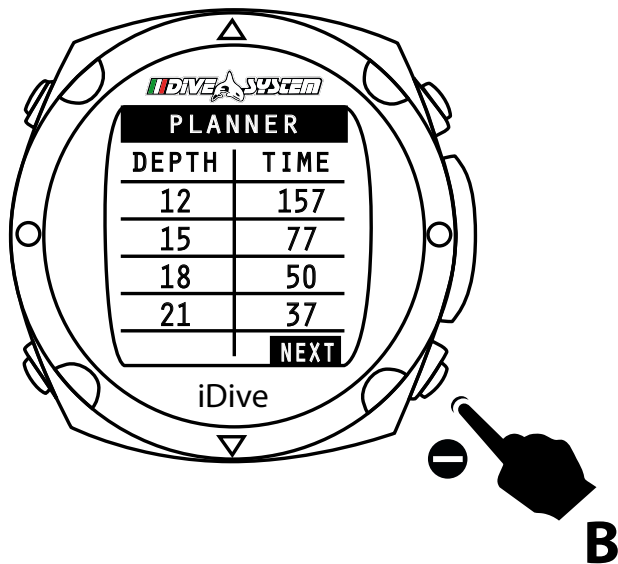

### ATTENTION:

If you find Dash line it means that this depth can not be planned in according with the MOD set.



## Logbook

By pressing the **B** or **D** you can scroll through the various menu items. Pressing **A** will access the function.

iDive store profiles of about 100 hours of diving. The data can be transferred to a PC using the software DiveLogger

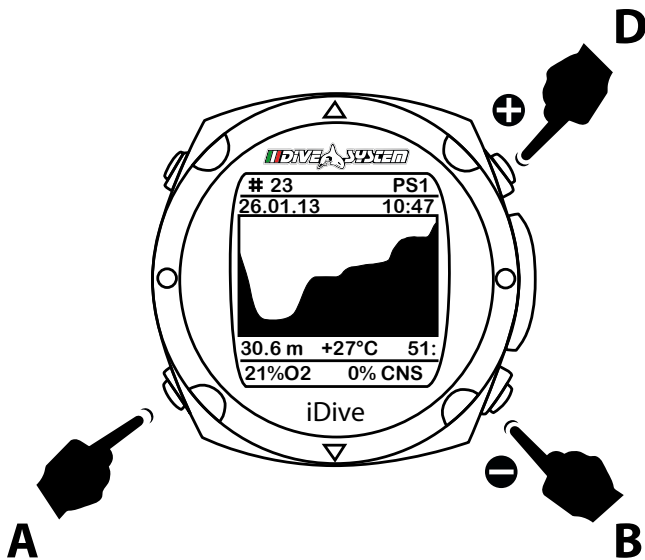

Press **B** or **D** key you can switch from the next or previous dive.

Pressing the **A** button to return to the watch function.



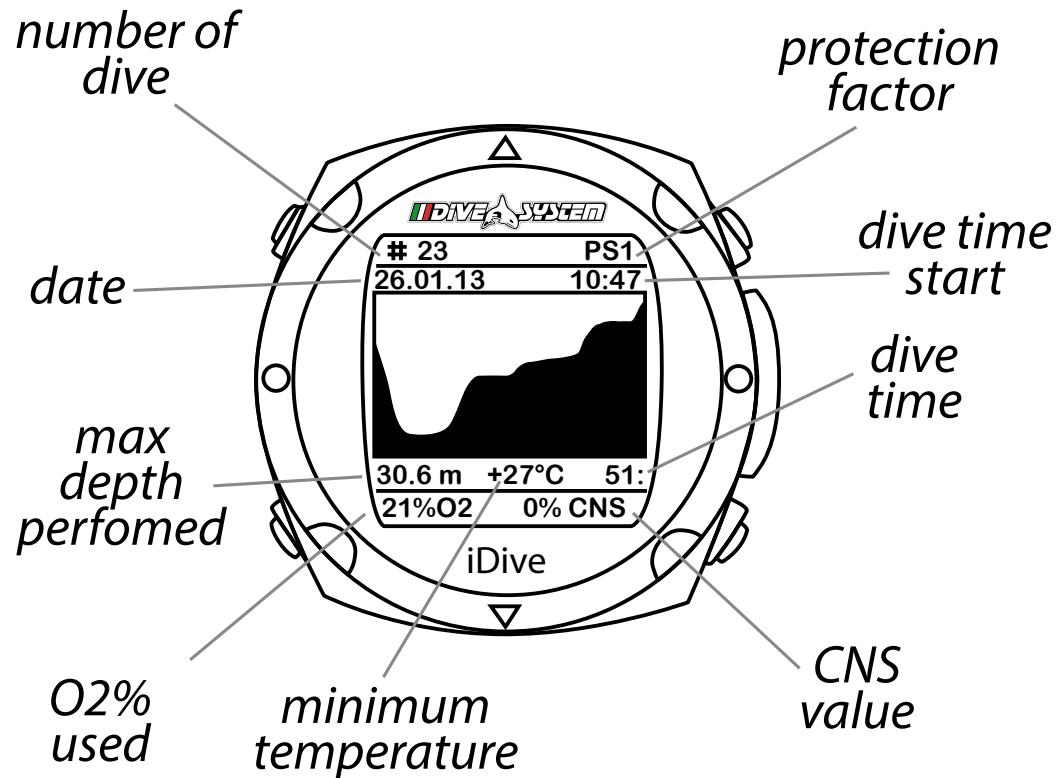

In the logbook menu is displayed a summary page that shows each dive that contain the following information:

- Progressive number of dives
- Protection level
- Date
- Hour
- Dive time
- Maximum depth
- Bottom Time
- Breathing gas (or mode in the event of Gauge and Free)
- Minimum temperature
- CNS value

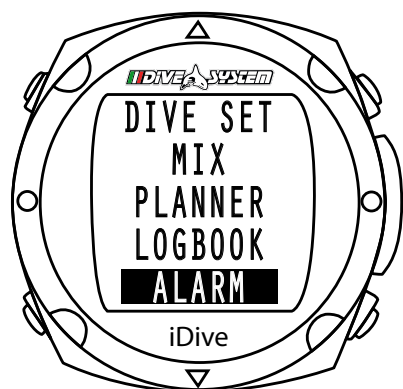

## Alarm

By pressing the **B** or **D** button you can scroll through the various menu items.

Pressing **A** will access the function.

With this function you can set the alarms.

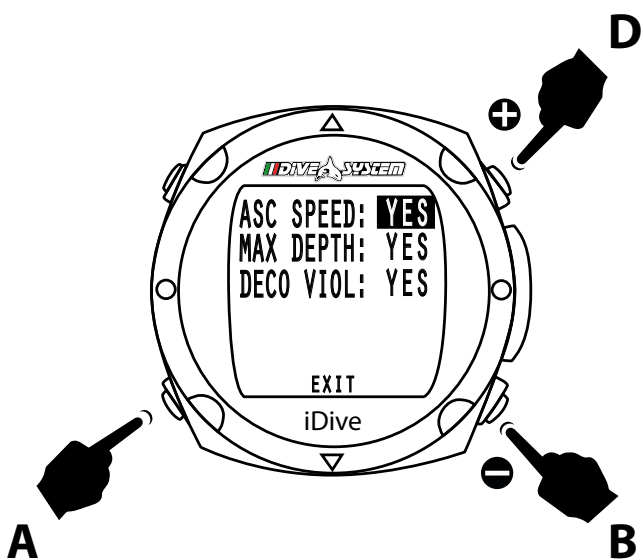

## ASC Speed

By pressing the **B** or **D** button can be activated alarm (YES) or disable (NO) the alarm of scent speed.

Press **A** button in order to confirm the setting and move to the next setting.

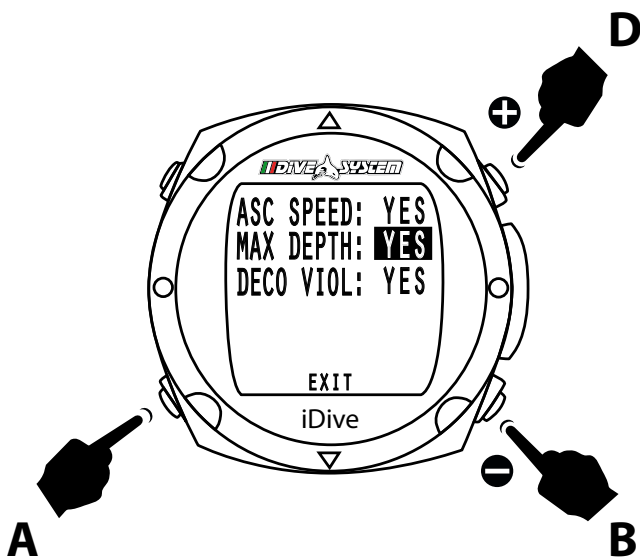

## **Max Depth**

By pressing the **B** or **D** button you can activate (YES) or disable (NO) alarm of maximum depth. the maximum depth depending on the PpO2 set and the gas used.

Press **A** to confirm the setting and move to the next setting.

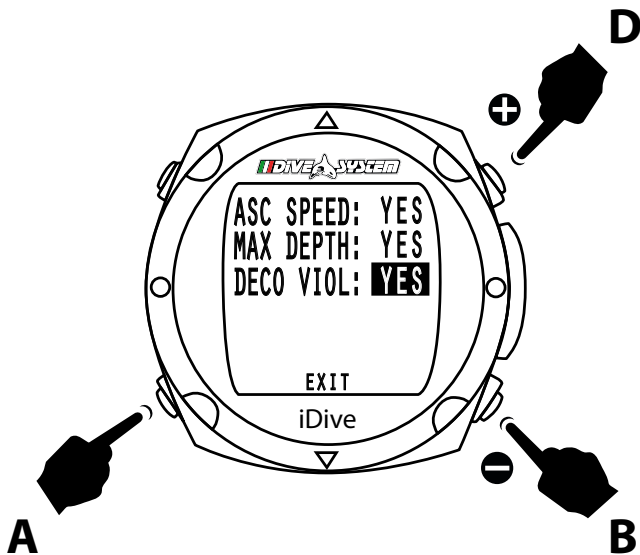

## **Deco Viol**

By pressing the **B** or **D** button can be activated (YES) or disable (NO) the alarm about deco violation.

Press **A** to confirm the setting and move to the next setting.

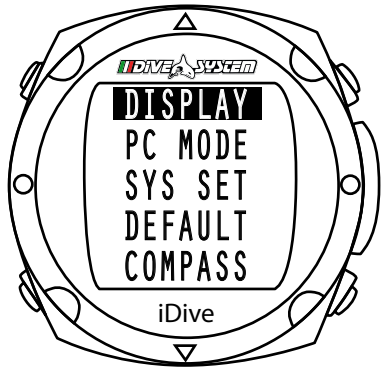

## Display

By pressing the **B** or **D** button you can scroll through the various menu items.

Pressing **A** button will access to this function.

This function allows you to adjust the display.

.

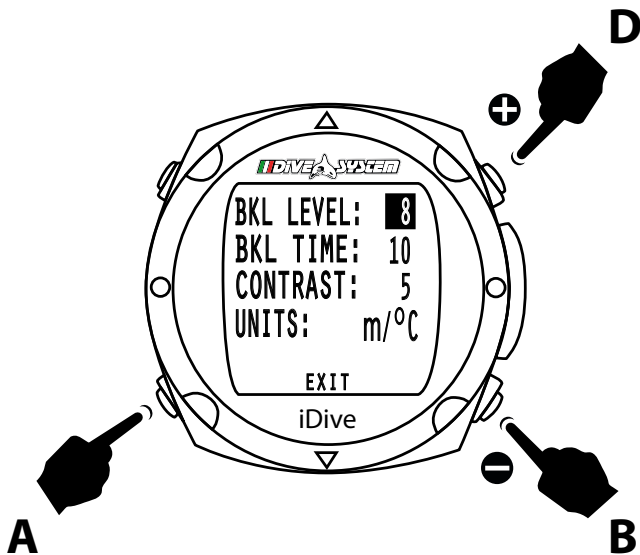

## BKL Level

By pressing the **B** or **D** button it is possible to increase or decrease the level of brightness of the display, from 0 to 10.

Press **A** to confirm the setting and move to the next setting.

**WARNING: A high value (10) decreases the autonomy of battery.**

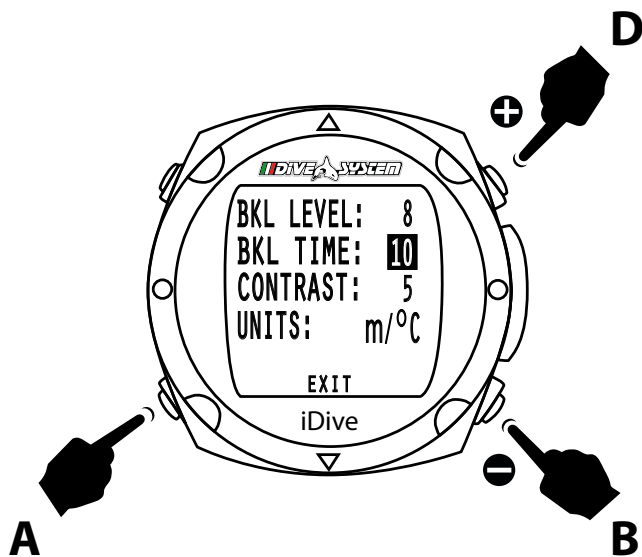

## **BKL Time**

By pressing the **B** or **D** button it is possible to increase or decrease the duration of the back light, from 1 to 30 seconds.

Press **A** to confirm the setting and move to the next setting.

**CAUTION: When the battery reaches a critical level the backlight is reduced or turned off.**

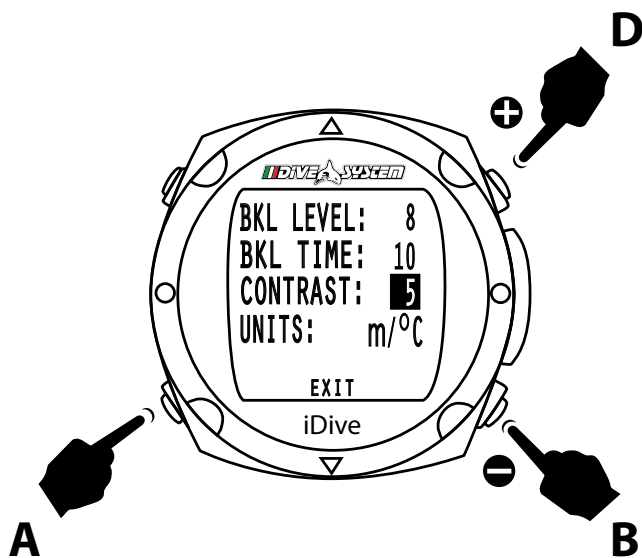

## **Contrast**

By pressing the **B** or **D** button it is possible to increase or decrease the contrast value of the display , from 1 to 7.

Press **A** to confirm the setting and move to the next setting.

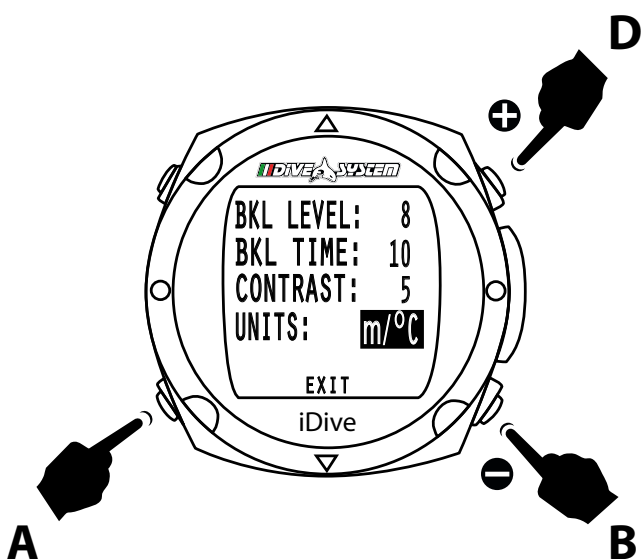

### Units

By pressing the **B** or **D** button you can set the unit metric or imperial system, m/°C - ft/°F.

Pressing **A** in order to confirm the value.

Pressing **D** button to return to watch mode.

.

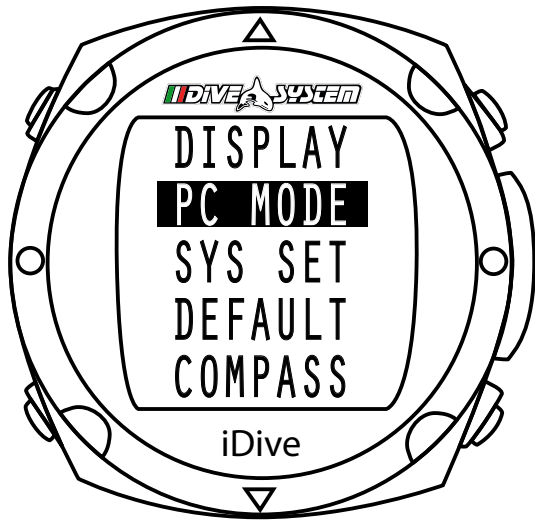

## PC Mode

By pressing the **B** or **D** you can scroll through the various menu items. Pressing **A** button in order to computer connection (PC) to download the dive profiles (Dive Logger)

By connecting the iDive to the PC also the battery is recharged.

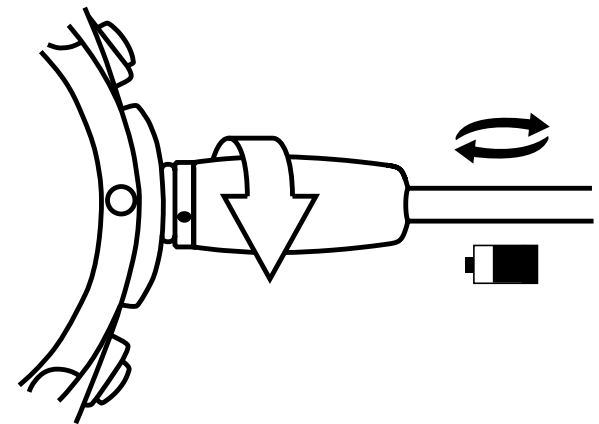

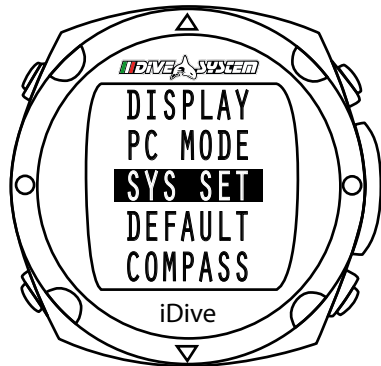

## Sys Set

By pressing the **B** or **D** button you can scroll through the various menu items.

Pressing **A** button will access to the function.

This function allows you to set the time zone, date, time and the format

## UTC - Time zone

Pressing the **B** or **D** in this function it is possible to increase or decrease the time zone.

With the iDive can easily change the time when traveling to destinations with a different time zone.

Pressing **A** button to move to the next setting

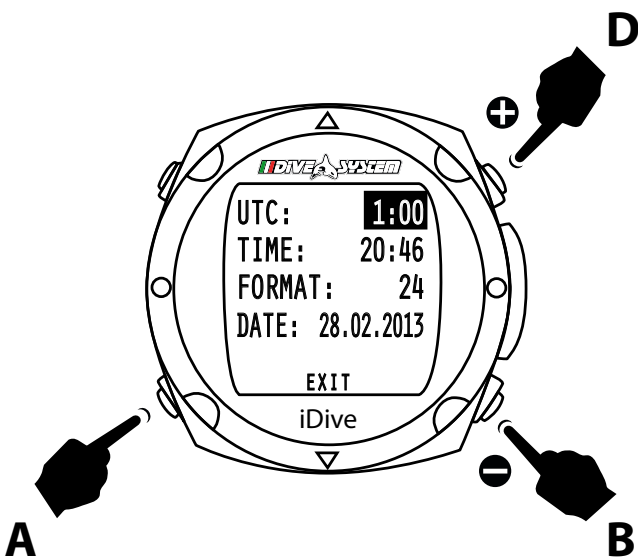



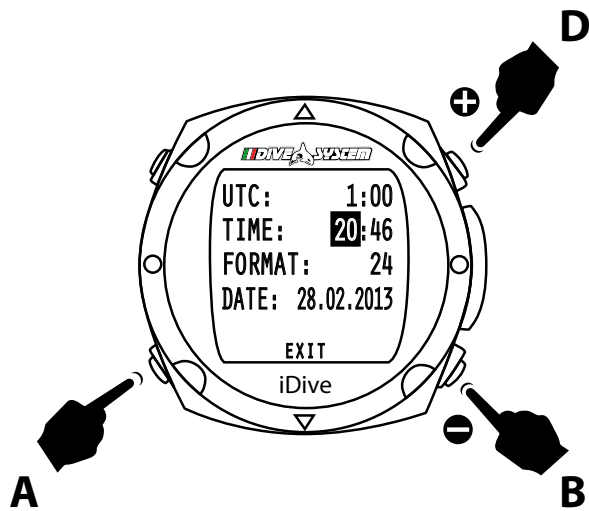

## Time

Set the hour and minutes.

Pressing the **B** and **D** buttons to set the time.

Pressing **A** to move to minutes set and **B** or **D** to set the minutes.

Press **A** button to confirm and move to the next.

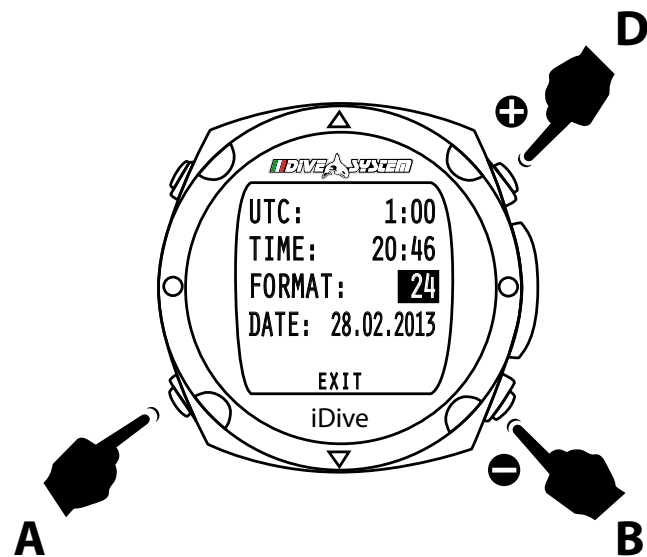
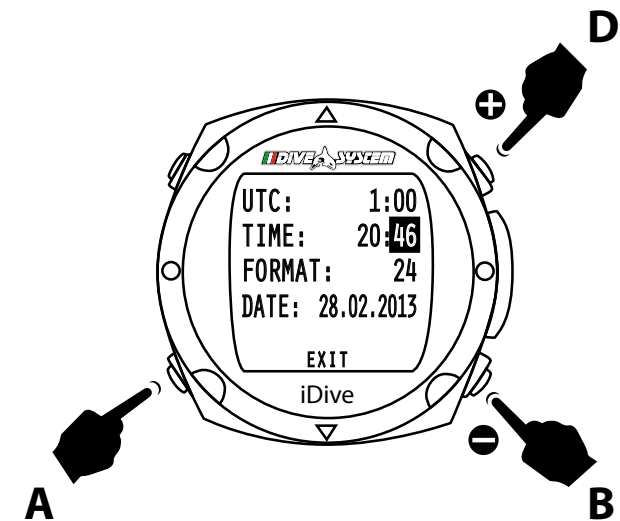

## Format

Pressing **B** and **D** buttons in order to change the hour format (24 or 12).

Pressing the **A** button in order to confirm the setting and move to the next.

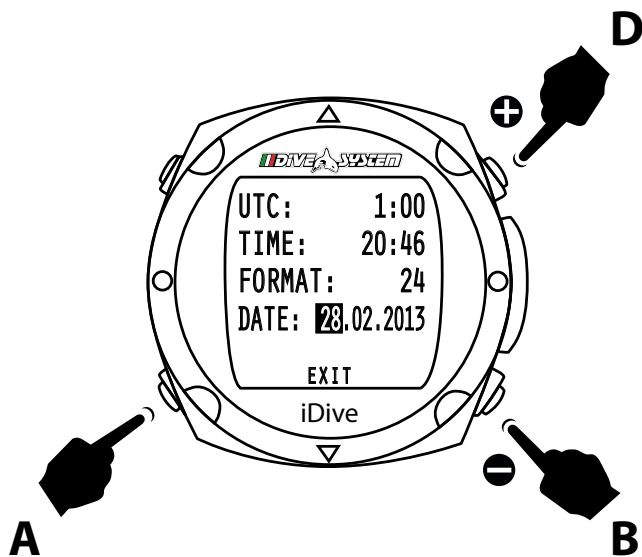

## Date

Is possible to set day, month and year.

Press the **B** and **D** buttons to select the exact day.

Pressing the **A** button to confirm the setting and changes the setting of the month and once you set the month, press the **A** button to confirm the setting changes the setting of the year.

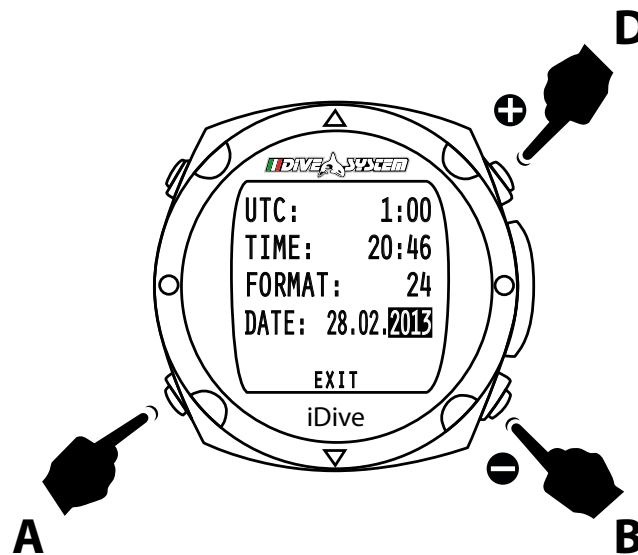
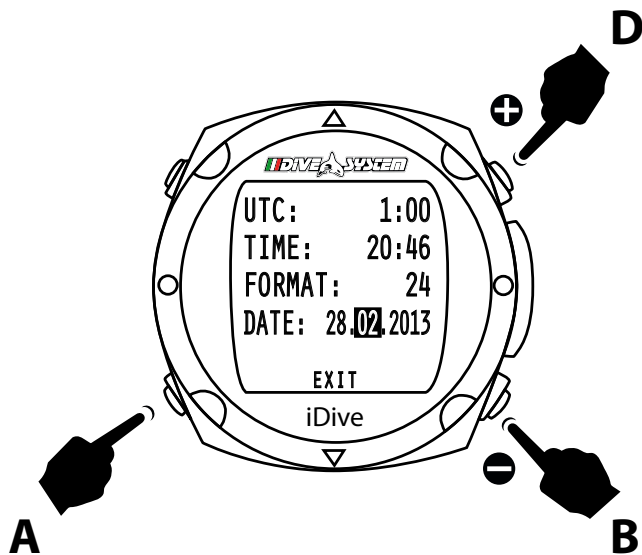

Pressing the **A** button the cursor place of EXIT by pressing the **B** button to confirm the setting returns to the clock function.

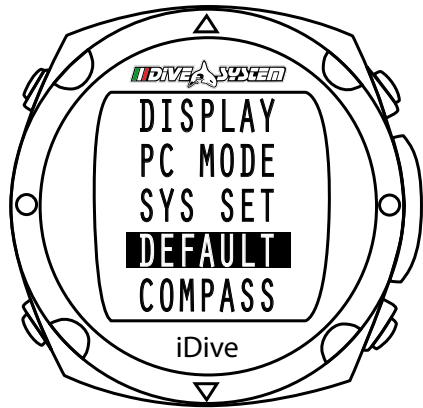

## Default

By pressing the **B** or **D** button you can scroll through the functions. Pressing **A** button in order to access.

Default set will reset the iDive to the factory value

Select with the **B** button the NO or YES and confirm with **A** button.

If you confirm this choose the I dive will reset to factory setting, the iDive will back in watch mode.

**Attention: All settings will be reset to the factory value.**

**Attention: The saturation data will not be reset.**

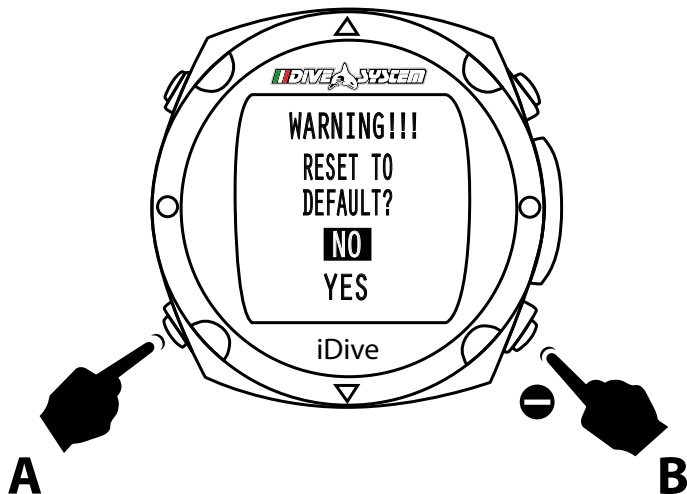

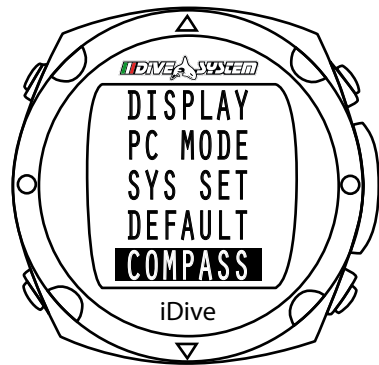

## Compass

By pressing the **B** or **D** you can scroll through the functions. Pressing **A** button in order to access .

With this function you can calibrate the compass and also the declination and direction.

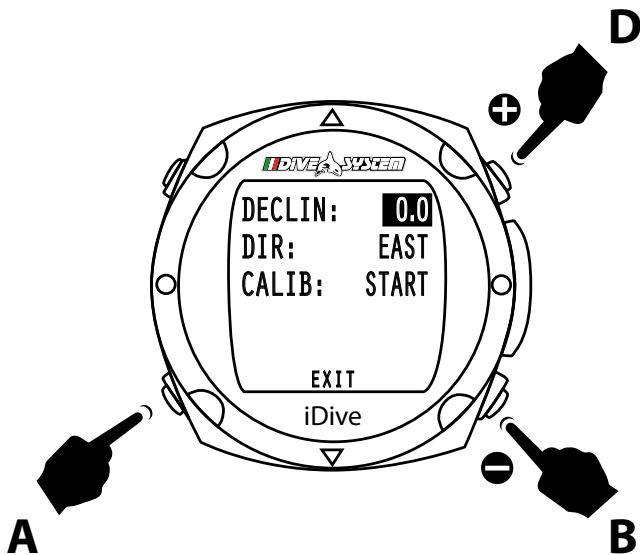

## Declin

By pressing the **B** or **D** in this selection can be increased or decrease the declination value.

The declination is used to compensate the difference between the north and magnetic north, you can get more information's by consulting the appropriate sites.

Pressing the **A** button to confirm the setting.

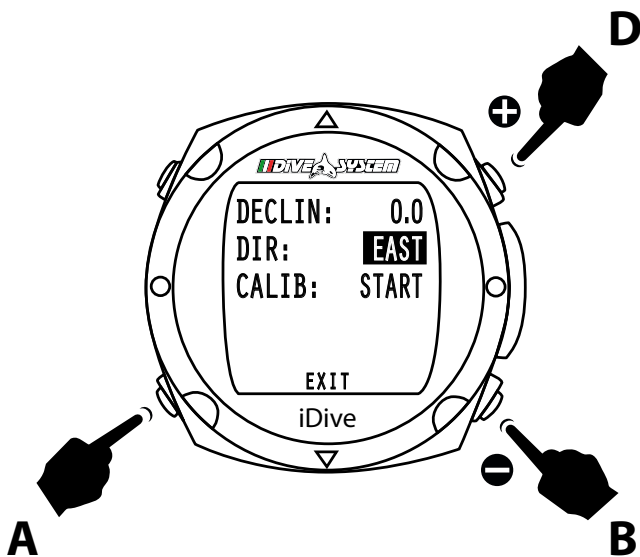

## Dir

By pressing the **B** or **D** button's you can set the direction, EAST or WEST..

The direction is used to indicate the direction of the declination of the Earth magnetic field.

Pressing the **A** button to confirm the setting and to move to the next setting.

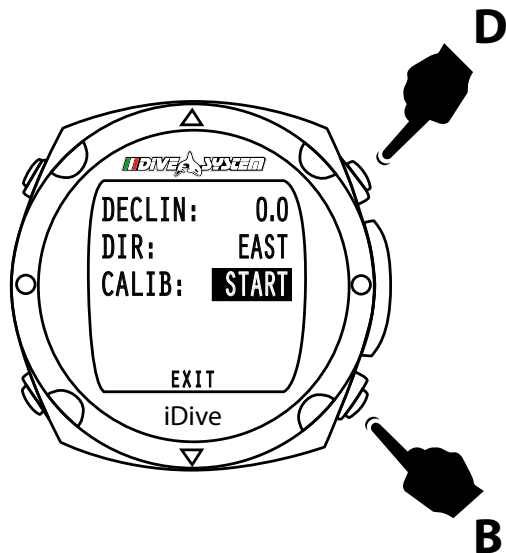

## Calib

You may need to calibrate the compass. By pressing the **B** or **D** instead of START appears ROTATE.

Take care to not expose the iDive, during this function, to electromagnetic fields and magnets that can affect the compass calibration and pres **B** or **D** button's.

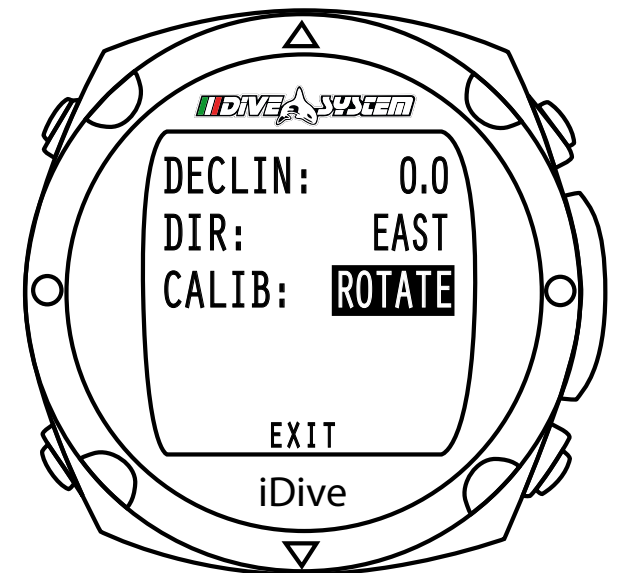

## Settings

Turn the computer on the horizontal plane up to TILT indication appear.

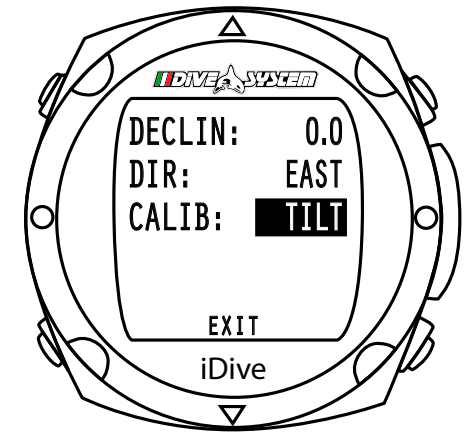
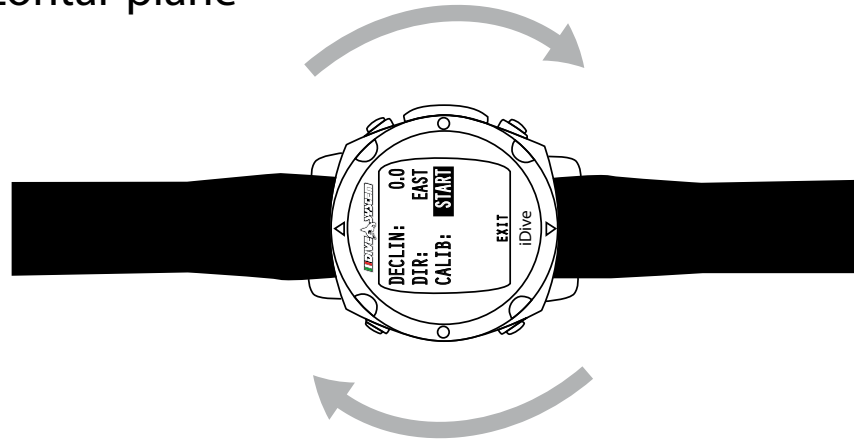

Rotate around the longitudinal axis until no signal appears OK as showed in the picture.

Now the compass is calibrated.

Pressing the **A** button in order to confirm all settings and EXIT, press **B** to exit from the submenu.

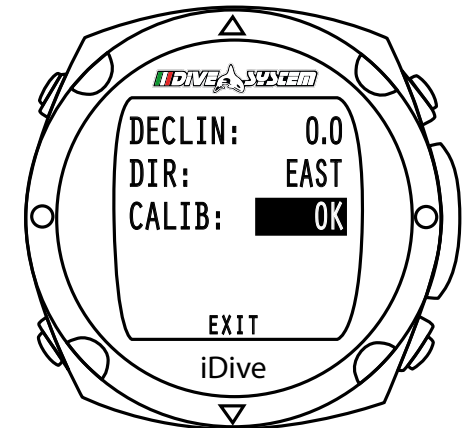
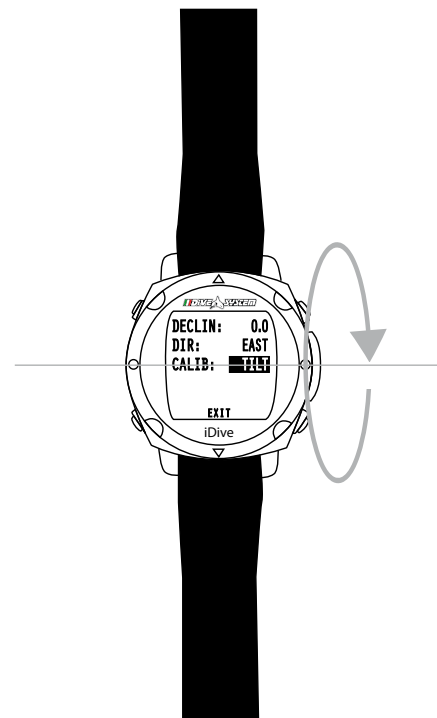

# iDIVE DURING DIVING

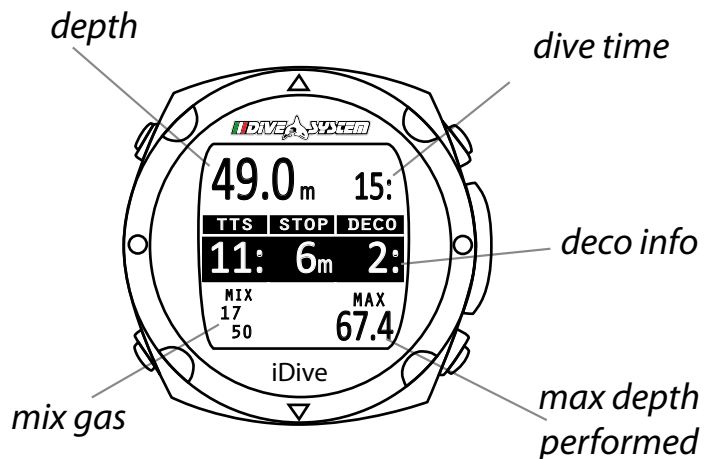

## Dive

iDive has been studied to provide to be user friendly during the dive.

This can helps the diver to receive the most important and clear information's.

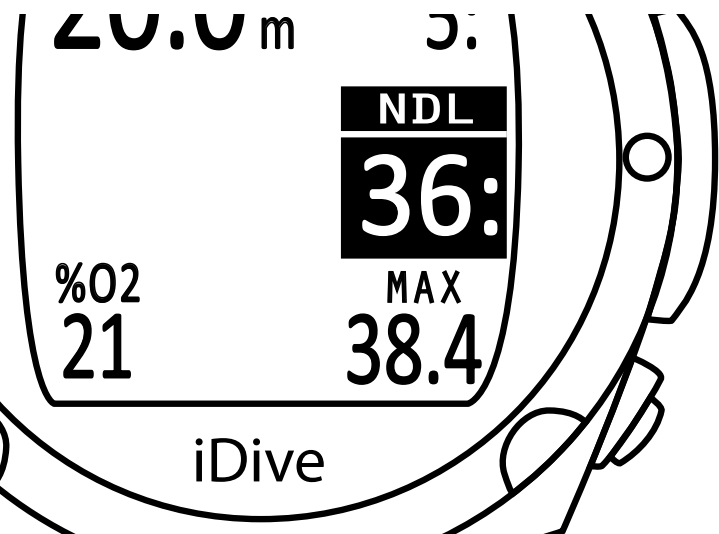

## NDL

The No Decompression Limit is the time that you can spend at the actual depth without decompression, is recommended not to exceed this limit.

Dive within the NDL is safer.

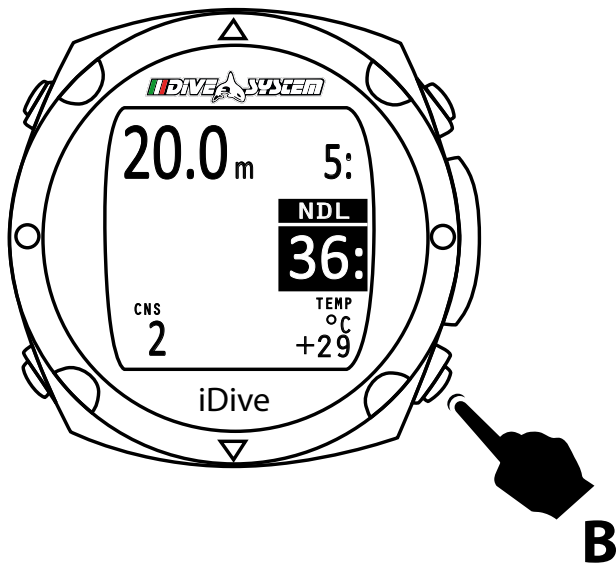

### CNS and temperature

During the dive by pressing the **B** button once at the bottom the display shows the data for the CNS, on the left, and temperature on the right.

Pressing the **B** button again shows the graph of the dive.

This function can be useful to review the type of profile runs from the diver up to that moment.

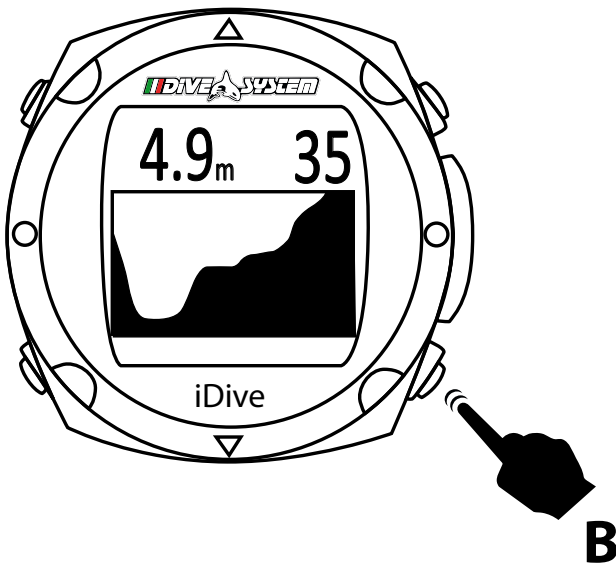

### Dive profile

iDive allows you to view your dive profile while you're still in the water.

Pressing the **B** button twice displays the dive graph, the current depth and dive time.

Pressing the **B** button, the screen returns to the iDive dive information.



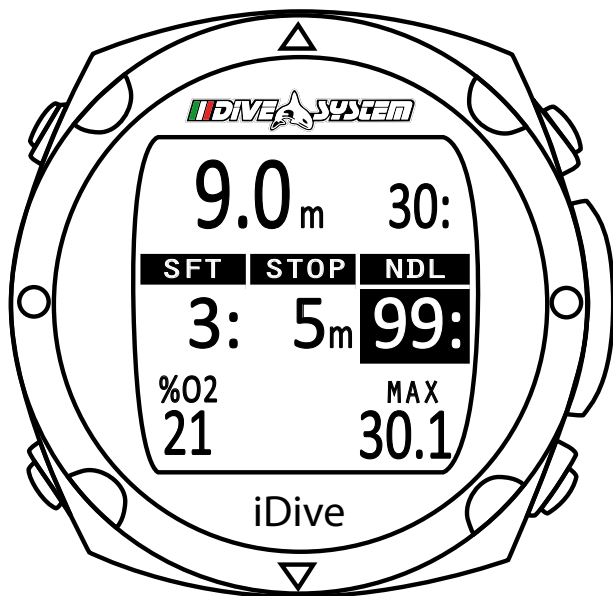

## Extra Safety Stop

In the event that you have set the safety stop, which is recommended for all dives, as per the instructions of paragraph Dive Set this will be displayed on the computer display during ascent from depth of 6.9 m.

The park is set by default to 5 m, can not be changed in the menu Dive Set you can set the minutes of this stop

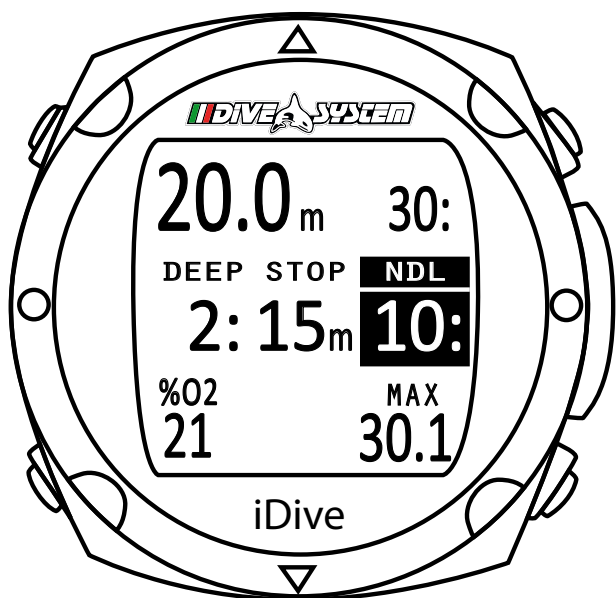

### Deep Stop

If you set Deep Stop function it appears 5m before the actual depth required and will be removed, if not done, 5 m after the required depth.

The display has been designed so that the deep stop data will show in the middle of the display.

In the event that the deep stop is made during no-stop Safety dive will remain visible the NDL time on the right side of the display on black background.

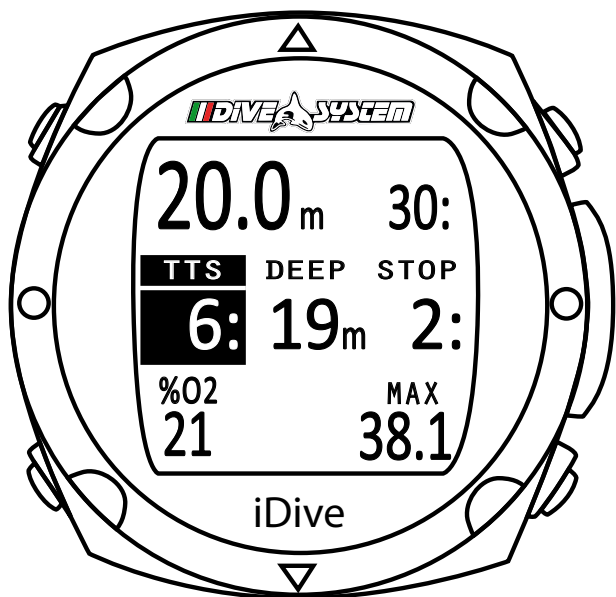

If the deep stop is carried out in dives with obligatory decompression stop, not recommended, the display will show the TTS (time to surface) obligatory stop time including, in the left part of the display (black background) followed by the meters and the time of deep stops.

The deep stop is not a mandatory stop and in the event that it fails the computer continues to show the dive data



### **Deco dive**

If the diver is required one or more mandatory decompression stop, not recommended, the central part of the display will be totally on a black background to draw attention to the diver. In the middle left of the display is the total time of ascent (TTS), is located next to the meter indication to which you must perform the first mandatory stop (STOP) and on the right the minutes related to the first mandatory decompression stop.

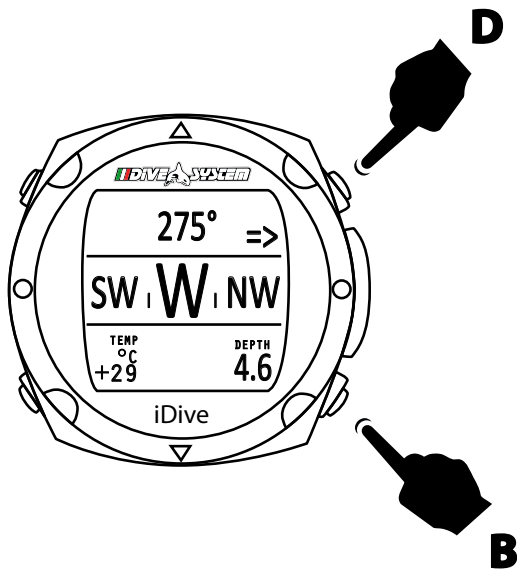

### Dive compass

Dive compass Pressing the **D** key to access to underwater navigation. In the upper part of the screen shows the direction (Grade ). In order to set a shipping lane press **B**.

As long as the direction that we are following is within the  $\pm 5^\circ$  from the set course is shown the value of the direction.

If you move from the set direction with an angle greater than  $\pm 5^\circ$  it will show an arrow that indicates the direction to follow to get back in the set direction.

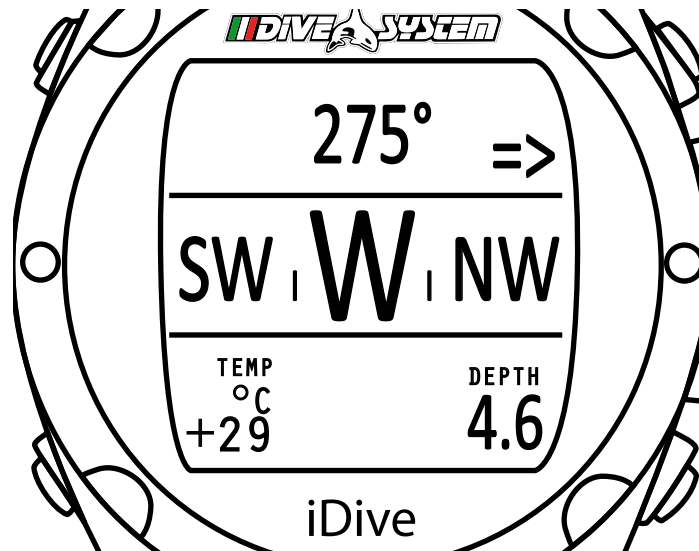

The electronic compass is able to correct the direction indicated for a tilt angle up to  $85^\circ$ .

The larger the tilt decreases the accuracy of the instrument up to a maximum of  $\pm 5^\circ$ .

In the lower part display will show the temperature on the left and the depth during the navigation .

### Switch gas during dive

If you have set one or more decompression deco gas, when you get to the depth determined by the MOD of the first deco gas, the display starts flashing the current gas in the lower left.

Pressing the **A** key you enter in switch gas screen .

With the button **A** you can select YES or NO and in order to confirm press the button **B** .

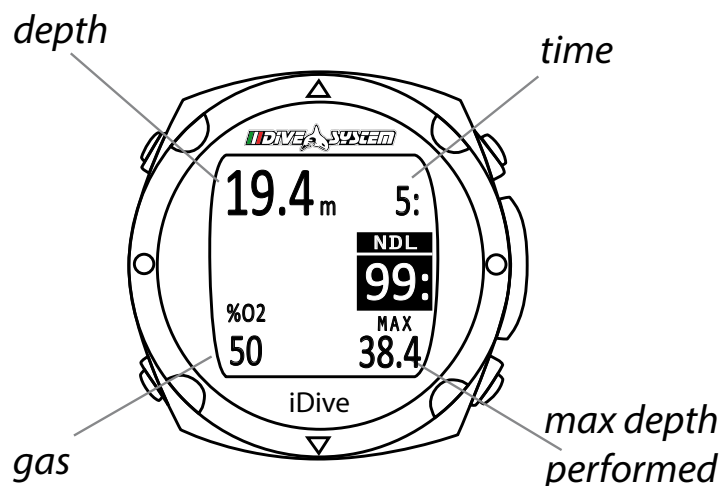
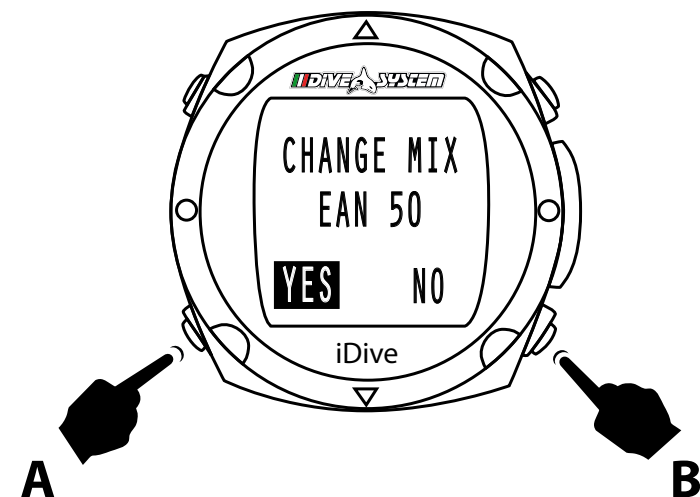

Once the switch gas is confirmed the iDive returns to the dive information

The new gas that you are using is indicated.

At each switch gas provide the same procedure

## iDIVE - THE DATA ON THE SURFACE

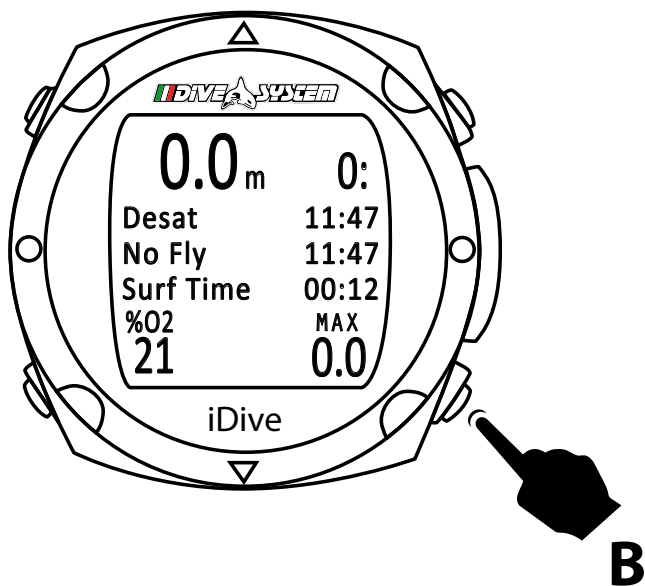

Once on the surface and 10 minutes has elapsed, by pressing the **B** button, you will see some important post-dive data as:

- Desaturation
- No Fly Time
- Surface

## iDIVE AFTER IMMERSION



### **No-Fly**

Dive System recommended to follow the DAN Pre flight interval guidelines

The current indications (DAN <http://www.diversalertnetwork.org/medical/faq/faq.aspx?faqid=54>) recommend:

- A minimum surface interval of 12 hours after a single dive before boarding a commercial aircraft.
- An interval of at least 24 hours to divers using scuba for several days or for repetitive dives or dives have required mandatory decompression stops.

These indications may vary due to new studies and research. Please check the if there are new research guidelines on this matter.

Make therefore always refer to the most current guidelines on the site if different from DAN those listed above.

### **WARNINGS**

**On the surface the computer iDive continues to give information about any errors, desaturation times, surface interval and NO FLY TIME**

**In GAUGE mode the no-fly time is always 24 hours.**

# iDIVE IN GAUGE

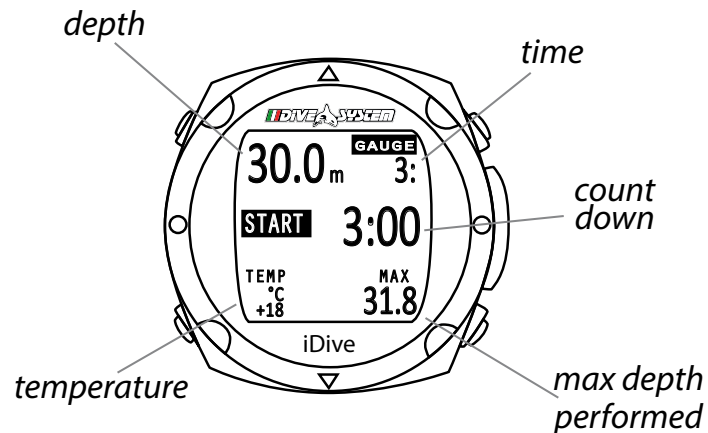

## Gauge

This mode allows you to use your computer as a common depth. iDive has the ability to set a countdown. The iDive is set by default with a time to count down to 3 minutes.

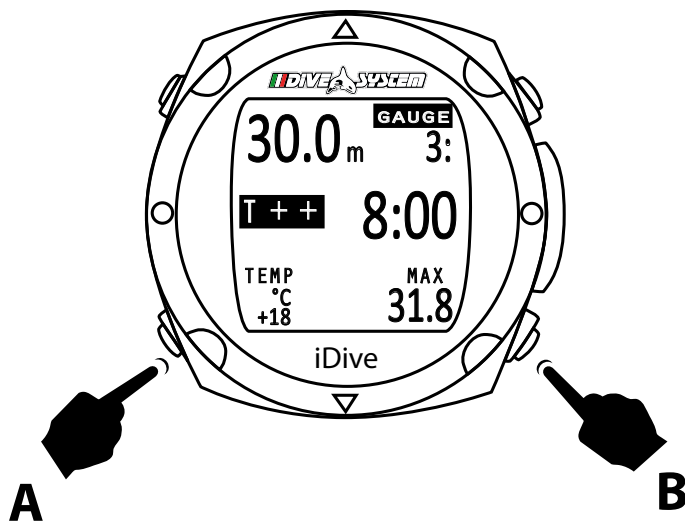

To activate the countdown, press **B**.

To increase the minutes, once in immersion press **A**.

During the dive the display will show START T ++ and pressing the **B** button you can increase the time, up to a maximum of 9:59.



## iDive in Gauge

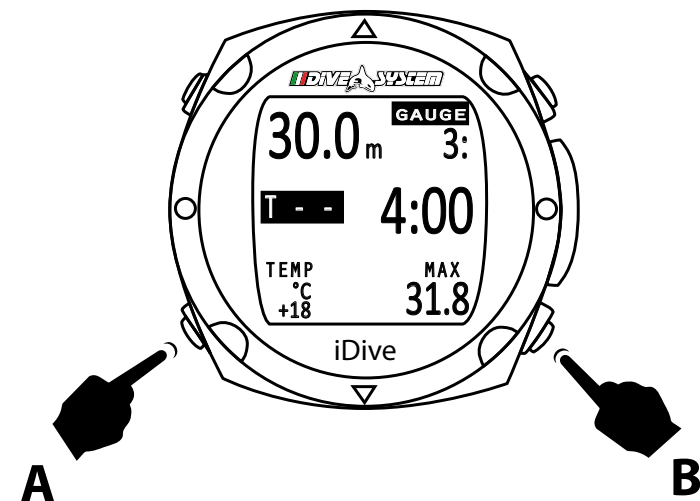

Pressing the **A** button in order to show T + + or T - -.

Pressing the **B** button you can decrease the time to a minimum of 0:30

# iDIVE IN FREE

## ATTENTION:

**This function is not available and can not be accessed if the user have dived ,within 24 hours with Dive Mode or Gauge mode.**

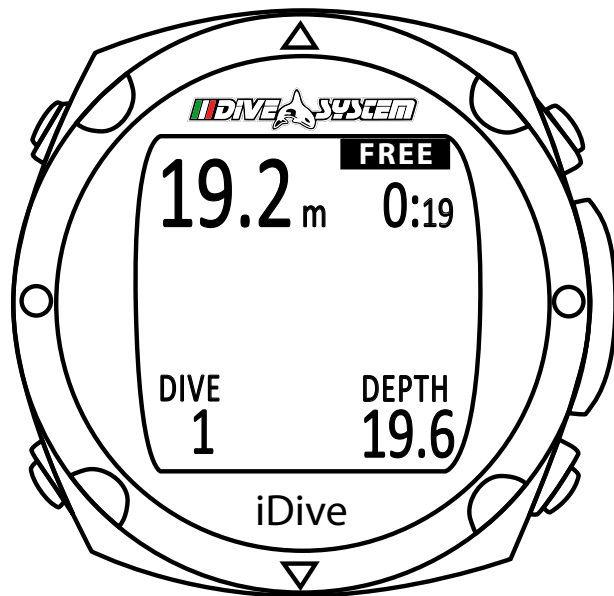

### Free mode during dive

If your diving computer is set in Free mode this function will be maintained for 15 minutes after which it will return in the Watch mode.

If the surface interval between dives is higher than 15 you will have to set your computer back on free mode and will be considered as a new series of free diving.

During free diving the computer show the data for the dive in progress. In the upper left is the current depth and right part the dive time, down on the left the dives number in the lower right part maximum depth of the dive.



Pressing the **B** button the display will show the temperature of the water on the left and on the right the maximum depth reached during the entire session dive.

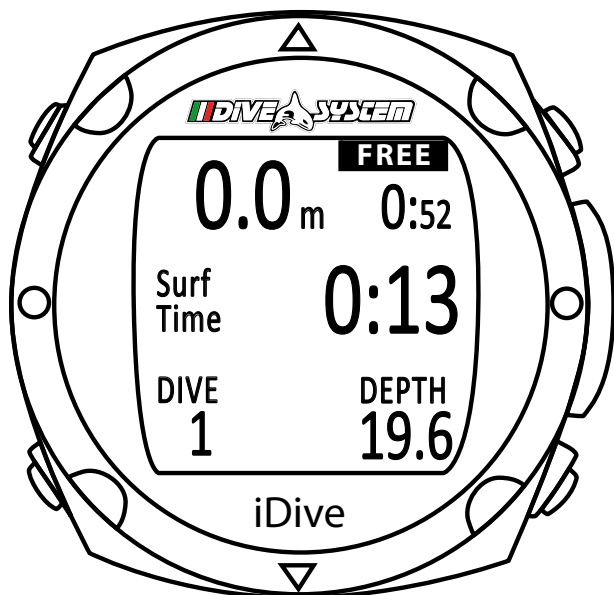

### Free mode on the surface

On the surface iDive shows the data of the last dive, on the left the depth at zero value and on the right the button time of the last dive.

In the central part of the display will shows the surface interval and in the lower left part total number of dives performed in the series and in the lower right part the maximum depth reached during last dive.

## TROUBLESHOOTING

Driver not found	<ul style="list-style-type: none"><li>• plug the usb cable to pc</li><li>• unistall the usb cable from pc (from PC device manager)</li><li>• unplug the usb cable to pc</li><li>• install the DiveLogger</li><li>• open the DiveLogger</li><li>• plug the usb cable to pc</li><li>• reinstall the usb cable driver</li></ul>
Battery drains out very fast	Recharge the iDive a whole night using a USB wall charger.
CRC Error	<ul style="list-style-type: none"><li>• open the DiveLogger</li><li>• plug the USB cable to PC and to iDive</li><li>• select the correct COM port (the COM is assigned automatically by your PC) from <b>Setup button</b></li><li>• click on <b>Update</b> on DiveLogger</li></ul>



©2013 Dive System

Dive System srl  
Via Vetturini 22/24 Valpiana - Massa Marittima (GR) Italy  
[www.divesystem.com](http://www.divesystem.com)