

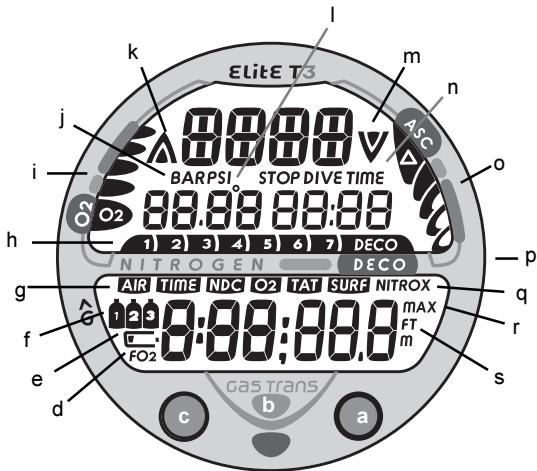

ELITE T3

DIVE COMPUTER

OPERATING MANUAL



Elite T3 FULL LCD

Components:

- a. Advance (A) Button
- b. LED Warning Light
- c. Mode/Mix (M) Button
- d. Symbol - FO2
- e. Icon - Low Battery
- f. Icons - Tank (Gas) 1, 2, 3
- g. Symbols -AIR TIME
 - TIME NDC
 - TIME O2
 - TIME TAT
 - TIME SURF
- h. NIBG
- i. O2BG
- j. Symbol - PSI or BAR (Pressure)
- k. Icon - Ascend Arrow
- l. Icon - degrees (Temperature)
- m. Icon - Descend Arrow
- n. Symbol - STOP TIME
 - DIVE TIME
- o. VARI
- p. Select (S) Button
- q. Symbol - NITROX
- r. Symbol - MAX
- s. Symbol - FT or M (Depth)

CONTENTS

WARRANTY, NOTICES, DECOMPRESSION MODEL	7
FCC ID	8
INTRODUCTION AND GENERAL FEATURES AND DISPLAYS	9
INTERACTIVE CONTROL CONSOLE	10
OPERATING MODE STRUCTURE	11
AUDIBLE ALARM	12
SMARTGLO BACKLIGHT	14
POWER SUPPLY	15
BAR GRAPHS	17
PC INTERFACE	19
SYMBOLS AND ALPHA NUMERIC GRAPHICS	19
ALPHA / NUMERIC DISPLAYS	20
Tank Pressure Display	20
Depth Displays	20
Air Time Remaining Display	20
Date, Time, and Temperature Displays	21
FREE Dive Mode Displays	21
SURFACE SEQUENCE AND OPERATING MODES	23
OPERATING MODES	24
SURFACE MODE	24
NORM (Normal) Surface Main Display	25
NORM Surface Main Button Operations	26
Elite T3 Battery Status	27
Transmitter Status	27
SET MODES	28
SET F GROUP (FO2)	28
Set FO2 for NORM Nitrox Dives	29

CONTENTS (continued)

Set FO2 GAS 1	31
Set FO2 GAS 2	32
Set FO2 GAS 3	33
Set FO2 50% Default	34
SET A GROUP (NORM/GAUG ALARMS)	34
Set Audible Alarm	35
Set Depth Alarm	36
Set EDT (Elapsed Dive Time) Alarm	37
Set NIBG (Nitrogen Loading Bar Graph) Alarm	38
Set DTR (Dive Time Remaining) Alarm	39
Set Turn Pressure Alarm (TMT1)	40
Set End Pressure Alarm	41
Set PO2 Alarm	42
SET U GROUP (UTILITIES)	43
Set Wet Activation	44
Set Units of Measure	45
Set NORM Safety Stop	46
Set Conservative Factor	47
Set Backlight Duration	48
Set Sampling Rate	49
Set TMT1 (Transmitter 1 Link Code)	50
Set TMT (Transmitter) 2-3 Use	52
Set TMT2/BUD1 (Transmitter 2 Link Code)	53
Set TMT3/BUD2 (Transmitter 3 Link Code)	55
SET T GROUP (TIME/DATE)	57
Set Hour Format	58
Set Time	58
Set Date	59
SERIAL NUMBER (Elite T3)	60
NORM SURF ALT DISPLAY (SURFACE ALTERNATE)	61
NORM PLAN MODE	61
FLY MODE	64
SAT MODE (DESATURATE)	66

CONTENTS (continued)

NORM/GAUG LOG MODE	67
NORM/GAUG HISTORY MODE	72
OVERVIEW OF DISPLAYED SYMBOLS AND ICONS	74
OVERVIEW OF DIVE MODE OPERATION	75
POSITIONING OF THE ELITE T3	77
Link Interruption Underwater	77
DIVE TIME REMAINING (DTR)	78
No Decompression Dive Time Remaining (NDC)	79
Oxygen Accumulation Time Remaining (OTR)	80
Air Time Remaining (ATR)	80
Air Time Remaining Alarm	81
ASCENT RATE ALARM	82
CONTROL OF DISPLAYS	83
WET CONTACTS	84
NORM TYPE DIVE MODES	85
NORM NO DECOMPRESSION DIVE MODE	86
NORM Dive No Deco Safety Stop	89
DECOMPRESSION DIVE MODE	91
VIOLATION MODES	95
NORM HIGH PO2	100
HIGH OXYGEN ACCUMULATION	101
SUMMARY OF NORM/GAUG WARNING AND ALARM MESSAGES	102
SWITCHING GAS MIXES AND BUDDY PRESSURE CHECK	103
SWITCHING GAS MIXES (NORM ONLY)	104
BUDDY PRESSURE CHECK (NORM ONLY)	109
NORM POST DIVE MODES	113
TRANSITION PERIOD	114
AFTER THE TRANSITION PERIOD	116

CONTENTS (continued)

GAUGE OPERATING MODE	117
GAUG SURFACE DISPLAYS	118
GAUG DIVE DISPLAYS	119
FREE DIVE OPERATING MODE	121
FREE SURFACE DISPLAYS	122
FREE COUNTDOWN TIMER (CDT)	124
SET FREE CDT	126
SET FREE EDT (ELAPSED DIVE TIME) ALARM	127
SET FREE DEPTH ALARMS	128
FREE DIVE DISPLAYS	132
FREE DIVE ALARMS	133
ENTRY INTO DECO DURING A FREE DIVE	136
REFERENCE	137
UPLOADING SETTINGS AND DOWNLOADING DATA	138
PC Compatibility Requirements	139
CARE AND CLEANING	140
INSPECTIONS AND SERVICE	140
BATTERY REPLACEMENT	142
INSTALLING A TRANSMITTER ON A REGULATOR	148
TRANSMITTER COMPATIBILITY WITH NITROX	148
ALTITUDE SENSING AND ADJUSTMENT	149
CHARTS OF NO DECOMPRESSION LIMITS AT ALTITUDE	150
CHART OF OXYGEN EXPOSURE LIMITS	151
SPECIFICATIONS	152
INSPECTION/ SERVICE RECORD	159



Pay special attention to items marked with this Warning symbol.

LIMITED TWO-YEAR WARRANTY

For details, refer to the Product Warranty Registration Card provided. Register on-line at www.diveaeris.com

COPYRIGHT NOTICE

This operating manual is copyrighted, all rights are reserved. It may not, in whole or in part, be copied, photocopied, reproduced, translated, or reduced to any electronic medium or machine readable form without prior consent in writing from AERIS/2002 Design.

Elite T3 Operating Manual, Doc. No. 12-7201

© 2002 Design, 2006

San Leandro, CA USA 94577

TRADEMARK, TRADE NAME, AND SERVICE MARK NOTICE

AERIS, the AERIS logo type, Elite T3, the Elite T3 logo, Air Time Remaining (ATR), Diver Replaceable Batteries, Graphic Diver Interface, Nitrogen Loading Bar Graph (NIBG), Pre Dive Planning Sequence (PDPS), SmartGlo, Set Point, Control Console, Turn Gas Alarm, and AERIS Computer Interface (ACI) are all registered and unregistered trademarks, trade names, and service marks of AERIS. All rights are reserved.

PATENT NOTICE

U.S. Patents have been issued, or applied for, to protect the following design features:

Air Time Remaining (U.S. Patent no. 4,586,136 and 6,543,444) and Data Sensing and Processing Device (U.S. Patent no. 4,882,678). Set NIBG Alarm and other patents pending. User Setable Display (U.S. Patent no. 5,845,235) is owned by Suunto Oy (Finland).

DECOMPRESSION MODEL

The programs within the Elite T3 simulate the absorption of nitrogen into the body by using a mathematical model. This model is merely a way to apply a limited set of data to a large range of experiences. The Elite T3 dive computer model is based upon the latest research and experiments in decompression theory. **Still, using the Elite T3, just as using the U.S. Navy (or other) No Decompression Tables, is no guarantee of avoiding decompression sickness, i.e. "the bends."** Every diver's physiology is different, and can even vary from day to day. No machine can predict how your body will react to a particular dive profile.



WARNING: If your Elite T3 stops working for any reason while operating as a Dive Computer, it is important that you have anticipated this possibility and are prepared for it. This is an important reason for not pushing the no decompression and oxygen exposure limits, and a critical reason to avoid entering decompression. If you dive in situations where your trip would be ruined or your safety would be jeopardized by losing the use of your Elite T3, a backup instrument system is highly recommended.

FCC ID: MH8A

FCC COMPLIANCE:

This equipment complies with Part 15 of the FCC Rules. Operation is subject to the following two conditions: 1. this equipment may not cause harmful interference, and 2. this equipment must accept any interference received, including interference that may cause undesired operation.

FCC INTERFERENCE STATEMENT:

This equipment has been tested and found to comply with the limits for an Intentional Radiator, a Class B Digital Device, pursuant to Part 15 of FCC Rules, Title 47 of the Code of Federal Regulations. These rules are designed to provide reasonable protection against harmful interference in a commercial or residential installation. This equipment generates, uses and can radiate radio frequency energy and, if not installed and used in accordance with the instructions, may cause harmful interference to radio communications.

There is no guarantee that interference will not occur in a particular installation. If this equipment does cause interference to radio or television reception, which can be determined by turning the equipment off and on, the user is encouraged to try to correct the interference by one or more of the following measures:

- Reorient or relocate the receiving antenna.
- Increase the separation between the equipment and receiver.
- Connect the equipment to an outlet on a circuit different from that to which the receiver is connected.
- Consult the dealer or an experienced radio/TV technician.



Warning: Changes or modifications to this unit not expressly approved by AERIS/2002 Design could void the user's authority to operate the equipment.



WARNING: Prior to diving with the Elite T3, you must also read and understand the AERIS Dive Computer Safety and Reference Manual, Doc. No. 12-7203, which provides Important Warnings and Safety Recommendations as well as general product information.

INTRODUCTION AND GENERAL FEATURES AND DISPLAYS

INTRODUCTION

Welcome to AERIS and thank you for choosing the Elite T3 !

It is extremely important that you read this Operating Manual in sequence and understand it completely before attempting to use the Elite T3 as a dive computer.

It is equally important that you read the AERIS Dive Computer Safety and Reference Manual (Doc. No. 12-7203) provided with your Elite T3. It contains information that you must become familiar with prior to diving with your Elite T3.

Remember that technology is no substitute for common sense, and a dive computer only provides the person using it with data, not the knowledge to use it.

INTERACTIVE CONTROL CONSOLE

The Interactive Control Console consists of 3 Control Buttons that allow you to select mode options and access specific information. They are also used to link the Transmitter(s), enter Settings, activate the Backlight, and acknowledge the Audible Alarm.

Throughout this manual they will be referred to as the M, S, and A buttons.

- Left/Front - Mode (M) button
- Right/Front - Advance (A) button
- Right/Side - Select (S) button

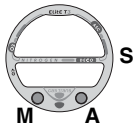

OPERATING MODE STRUCTURE

The M button is used to access 3 operating Modes (Fig. 1) that include NORM (Normal Air/Nitrox Dive Computer), GAUG (Digital Gauge Mode), and FREE (Free Dive Mode).

The screens of the Main Modes and Sub Modes will remain on display until a button is pressed to access another screen or Mode, activate a sequence, or for 2 minutes if no button is pressed.

When Wet Activation is set On, the Elite T3 will enter the selected Dive Mode upon descent to 5 FT (feet) / 1.5 M (meters), regardless of what surface screen is displayed at the time.

⚠ WARNING: When Wet Activation is set OFF, the Elite T3 must be activated by push button prior to the first dive of a new series. Commencing a dive will not activate Dive Mode unless Wet Activation is set ON or the unit is activated.

Entering Settings and Plan Mode are available in NORM SURF Mode which also allows access to Battery/Transmitter Status, Fly, Desat, Log, and History Modes. Tank Pressure is displayed if a Transmitter is active and Linked with the Elite T3.

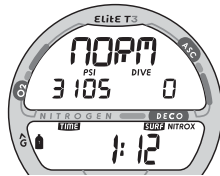

NORM (Normal Air/Nitrox)



GAUG (Digital Gauge Mode)

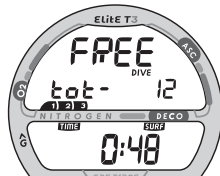

FREE (Mode)

Fig. 1 - Operating Modes

GAUG Surface Mode allows access to Battery/Transmitter Status, Fly, Log, and History Modes. It also displays Tank Pressure.

FREE Mode allows access to sub modes by first accessing NORM Surface Mode. It does not display Tank Pressure.

Once a dive is made in GAUG Operating Mode, the Elite T3 is locked into that Mode for 24 hours after the dive.

The Elite T3 also features 2 modes for use of Transmitter Pressure. A setting allows you to choose whether Transmitters 2 and 3 are for your use (SELF) or for checking 1 or 2 Buddies' Tank Pressure(s). The setting remains fixed until changed in the NORM/GAUG SET U menu.

AUDIBLE ALARM

Most warning situations that activate the Audible Alarm while operating in NORM or GAUG Mode cause the Elite T3 to emit 1 beep per second for 10 seconds, or until the situation is corrected, or it is acknowledged by momentarily pressing and releasing the S button (less than 2 seconds). After being acknowledged and the situation corrected, the Alarm will sound again upon reentry into the warning situation, or entry into another type of warning situation.

FREE Dive Mode has its own set of Alarms which emit 3 short beeps either 1 or 3 times which cannot be acknowledged or set Off.

A red LED Warning Light, located on the left side of the housing, is synchronized with the Audible Alarm. It will flash as the Audible Alarm sounds. It will turn Off when the Alarm is acknowledged or the situation is corrected. The Audible and LED will not be active if the Alarm is Set OFF (a group A setting).

Situations that will activate the NORM/GAUG 10 second Alarm include -

- Air Time Remaining (ATR) at 5 minutes, then again at 0 minutes.
- ATR becomes less than No Deco and O₂ Time Remaining for 1 minute.
- Turn Pressure at the Set Point selected (Transmitter 1).
- End Pressure at the Set Point selected (active Transmitter).
- Descent deeper than the Max Depth Set Point selected.
- Dive Time Remaining at the Set Point selected.
- Elapsed Dive Time at the Set Point selected.
- High PO₂ of 1.60 ATA or the Set Point selected.
- High O₂ of 300 OTU (single or daily exposure).
- Nitrogen Loading Bar Graph at the segment Set Point selected.
- NORM/GAUG Ascent Rate exceeds 60 FPM (18 MPM) when deeper than 60 FT (18 M), or 30 FPM (9 MPM) at 60 FT (18 M) and shallower.
- Loss of the active Transmitter Link signal for more than 15 seconds during a dive.
- Entry into Decompression Mode (Deco).
- Conditional Violation (above a required Deco Stop Depth for less than 5 minutes).
- Delayed Violation (above a required Deco Stop Depth for more than 5 minutes).
- Delayed Violation (a Deco Stop Depth greater than 60 FT/18 M is required).
- Delayed Violation (Maximum Operating Depth of 330 FT/100 M is exceeded).
- A Gas Switch to another tank would expose the diver to PO₂ greater than 1.60 ATA.

A single short beep (which cannot be disabled) is emitted for the following -

- Upon completion of a Hot Swap battery change.
- Change from Delayed to Full Violation 5 minutes after the dive.

3 short beeps (which cannot be disabled) are emitted for the following -

- Air Time Remaining becomes less than No Deco and O2 Time Remaining.
- FREE Dive Elapsed Dive Time Alarm (3 beeps every 30 seconds if set On).
- FREE Dive Depth Alarms 1/2/3 (set sequentially deeper) - each 3 beeps 3 times.
- FREE Dive NIBG Alarm (Caution zone, 7 segments) - 3 beeps 3 times.
- Entry into Deco during a FREE Dive (Permanent Violation) - 3 beeps 3 times.
- Free Dive Mode Countdown Timer reaches 0:00 - 3 beeps 3 times.

During the following NORM Dive situations, the 10 second Audible Alarm will not turn off when acknowledged -

- Ascending above a required Decompression Ceiling Stop Depth for more than 5 minutes (referred to as a Delayed Violation).
- Decompression requires a Ceiling Stop Depth of 70 FT/21 M or deeper.
- Being on the Surface for 5 minutes after a Conditional Violation.

SMARTGLO® BACKLIGHT

To activate the SmartGlo Backlight - press the S button.

- If ambient light level is low, the Backlight will activate and illuminate the display for button depression time* plus the user set Duration time of 0, 5, or 10 seconds, for a maximum of 20 seconds.
(*The Backlight will turn Off if the button is depressed for more than 10 seconds.)
- Press the button again to activate as desired.

△ NOTE: Extensive use of the Backlight reduces estimated Battery life. Also, the Backlight does not operate during a Low Elite T3 Battery Condition or when the Elite T3 is connected to a PC.

POWER SUPPLY

The Elite T3 utilizes one 3 volt CR2450 Lithium Battery. The Battery should operate normally for 1 year or 300 dive hours if 2 dives are conducted during each dive period. The Elite T3 checks its battery voltage every 2 minutes during surface operation.

- If voltage of the Elite T3 decreases to the Warning level (2.75 volts), the Battery icon will appear on Surface display screens (Fig. 2a) as an indication that the Battery should be changed prior to commencing a series of dives.
- If the Elite T3's voltage decreases to the Alarm level (2.50 volts), the Battery icon will flash and the Elite T3 will shut Off.
- Low Battery Warning/Alarm conditions are not displayed during Dive Modes.
- If a Low Battery Condition was not displayed prior to starting a Dive, and a Low Battery Condition occurs during the dive, there will be sufficient Battery power remaining to maintain operation for the remainder of that dive.

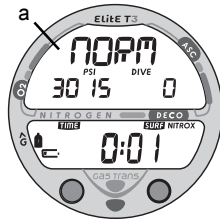

Fig. 2 - Low Battery Warning

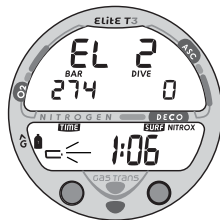

Fig. 3 - Low Battery Alarm

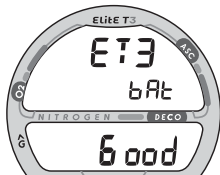

Fig. 4 - Battery Status (Good)

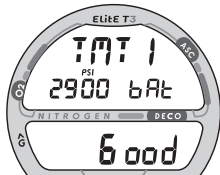

Fig. 5 - Transmitter 1 Battery Status (Good)



Fig. 6 - Transmitter 3 Status (Not Available)

Transmitters use one 3 volt, CR2 Lithium Battery. A Transmitter's battery should provide normal operation for 1 year or 300 dive hours. Transmitters check battery voltage when they are pressurized and will send a Low Battery signal to the Receiver in the Elite T3 when the voltage drops below the Warning level.

- Transmitter Low Battery Warning/Alarm conditions are only displayed on Status screens that can be accessed while viewing the NORM Surface Display.

To check the condition of the Elite T3 or a Transmitter's Battery if NORM or GAUG Mode is selected, depress the S button for 2 seconds while viewing the NORM or GAUG Surface Main Display, then release it.

- As the button is depressed, the VT3's Receiver will activate.
- 2 seconds later, the VT3's Battery status will be displayed for 3 seconds (Fig. 4), then -
- if active and linked, Transmitter 1's Battery status will be displayed for 3 seconds (Fig. 5), then -
- if active and linked, Transmitter 2's Battery status will be displayed for 3 seconds, then -
- if active and linked, Transmitter 3's Battery status will be displayed for 3 seconds, then -
- the display will then revert to Surface Mode.
- If a Transmitter is not active and linked, the message NotAvAil (not available) will be displayed (Fig. 6).

BAR GRAPHS

The Elite T3 features a Nitrogen Loading Bar Graph (NIBG) (Fig. 7a) that represents your relative no decompression or decompression status.

As your Depth and Elapsed Dive Time increase, segments will add to the NIBG, and as you ascend to shallower depths, the segments of the NIBG will begin to recede, indicating that additional no decompression time is allowed.

The NIBG monitors 12 different nitrogen compartments simultaneously and displays the one that is in control of your dive. It consists of 8 segments, the lower 7 represent No Decompression status and the 8th at the top indicates a Decompression condition.

When the Elite T3 is set to operate in NORM Nitrox mode, the 5 segment O₂ Bar Graph (O₂BG) (Fig. 7b) will represent oxygen accumulation.

Displays associated with oxygen and the O₂ Bar Graph will be displayed if FO₂ for any Gas (1, 2, or 3) has been set at a value other than 'Air' (e.g., a numerical value).

The O₂BG will show the maximum of either per dive accumulated oxygen or 24 hour period accumulated oxygen. As your oxygen exposure (accumulation) increases during a NORM dive, segments will add to the O₂BG, and as saturation decreases, it will begin to recede, indicating that additional exposure is allowed for that dive and 24 hour period.

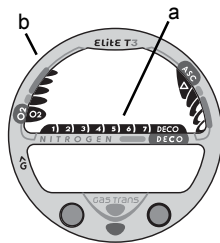

Fig. 7 - NIBG and O₂BG **17**

VARI

Deeper than 60 FT (18 M)

Segments	Ascent Rate =	
Displayed	FPM	MPM
0	0-20	0-6
1	21-30	6.1-9
2	31-40	9.1-12
3	41-50	12.1-15
4	51-60	15.1-18
5	60 +	18 +

60 FT (18 M) & Shallower

Segments	Ascent Rate =	
Displayed	FPM	MPM
0	0-10	0-3
1	11-15	3.1-4.5
2	16-20	4.6-6
3	21-25	6.1-7.5
4	26-30	7.6-9
5	30 +	9 +

The Elite T3 will store oxygen accumulation calculations for up to 10 dives conducted during a 24 hour period. If the maximum limit for NORM dive oxygen loading has been exceeded for that day (24 hour period), all of the segments of the O2BG will be displayed flashing.

Depth/Time values will not appear in Plan Mode until the O2BG recedes into the normal zone (lower 4 segments) indicating that your daily oxygen dosage has decreased an amount equivalent to the amount accumulated during the latest dive completed.

The Elite T3 also features a 5 segment NORM/GAUG Mode Variable Ascent Rate Indicator (VARI) (Fig. 8a) that provides a visual representation of ascent speed (i.e., an ascent speedometer). The segments of the VARI represent two sets of speeds which change at a reference depth of 60 feet (18 meters). Refer to the chart for segment values.

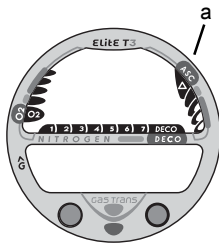

Fig. 8 - VARI



WARNING: At depths greater than 60 feet (18 meters), ascent rates should not exceed 60 feet per minute (18 meters per minute). At depths of 60 feet (18 meters) and shallower, ascent rates should not exceed 30 feet per minute (9 meters per minute).

PC INTERFACE

Interface with a PC is accomplished by connecting the Elite T3 to a PC USB Port using the USB Interface Cable provided. The same Cable is used for Upload and Download.

The software program is on the AERIS Computer Interface CD provided, together with a USB Driver. The program's Help section serves as the User Manual and can be printed for personal use. The Settings Upload program is used to check the Elite T3's existing Settings and for entering settings into the Elite T3. The Data Download program is used to retrieve Data that was sampled during dives and stored in the Elite T3's memory.

The Elite T3 checks for an External Access request once every second while in Surface Mode. Checks are not made if the unit is WET. For a connection to be made, the Interface Cable is plugged into the Elite T3's Data Port and plugged into a PC USB Port. To establish the connection, the PC program must be running. When the connection is made, all segments of the Elite T3 appear on the display until completion of the Upload or Download operation.

- The Elite T3 reverts to the Surface Mode Main screen after completion of the Upload or Download operation, or after 2 minutes if no PC action was taken.

SYMBOLS AND ALPHA NUMERIC GRAPHICS

The upper line of digits on the LCD screen is used to convey alpha Messages such as Day of the Week, Operating Modes, items being Set, Gas and Transmitter identification, Altitude level, and Alarm identification. At times, the second line is also used to display alpha numeric graphics such as PO2 and On/Off. The FO2 setting of a selected Gas will appear in the lower line.

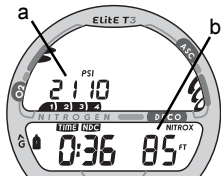

Fig. 9 - Dive Main Display

ALPHA / NUMERIC DISPLAYS

Tank Pressure Display (NORM/GAUG only)

When the Elite T3's Receiver is set ON and active, Tank Pressure from an active Transmitter that is properly linked will be displayed on the NORM or GAUG MAIN screens (Fig. 9a).

Values of Pressure are displayed numerically from 000 PSI (00 BAR) up to 5,000 PSI (345 BAR) in increments of 5 PSI (1 BAR).

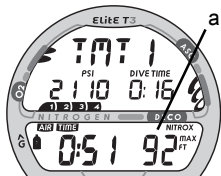

Fig. 10 - Dive Alt Display

Depth Displays (all Modes)

During dives, the **Current Depth** display (Fig. 9b) and **Maximum Depth** which is accessed as an Alternate Display (Fig. 10a) indicate Depths from 0 to 399 FT (120 M) in increments of 1 FT (.1 M).

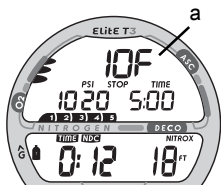

Fig. 11 - Safety Stop Display

During a No Decompression Safety Stop, the set **Stop Depth** (Fig. 11a) is displayed and during a Decompression condition, the required **Ceiling Stop Depth** is displayed. These Depths are displayed graphically on the top row of the screen with the letters F indicating Feet and M indicating Meters (ex: 10F = 10 Foot Stop and 9M = 9 Meter Stop).

Time, Date, Temperature Displays

Time of Day and NORM/GAUG Mode displays are shown in hour:minute format (i.e., 1:16 represents 1 hour and 16 minutes, not 116 minutes).

FREE Dive Mode displays are shown in minute:second format. The colon that separates hours and minutes (minutes and seconds) blinks once per second when the display is indicating real time (e.g., Surface Interval, Elapsed Dive Time), and is solid (non-blinking) when times are calculated projections (e.g., Time to Fly, Plan).

The **Primary Time** display, at the bottom of the screen, has the largest digits of the display (Fig. 12a). Another **time** display (Fig. 12b) is located in the middle row. Both displays are identified by the symbol TIME.

There is an Alternate Display providing **Day of Week, Temperature, and Time of Day**. This common display (Fig. 13) can be accessed while operating in NORM, GAUG, or FREE Modes while on the Surface and during Dives.

Date is displayed only to identify dives when they are accessed in the LOG Mode. When set for Imperial Units, Month is to the left of Day (Fig. 14a) separated by a decimal point (month.day). When set for Metric, Month is to the right of Day (day.month).

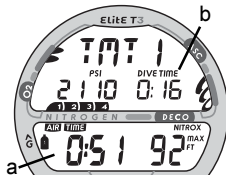

Fig. 12 - Time Displays

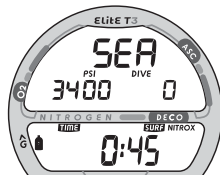

Fig. 13 - Time of Day

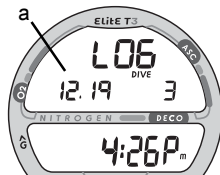

Fig. 14 - Date (Log Mode)



NOTE: Each display represents unique pieces of information. It is imperative that you understand the formats, ranges, and values of the information represented to avoid any possible misunderstanding that could result in error.

You must also understand the icons, symbols, and alpha/numeric messages presented.

The Informational Displays are described in detail as the various operating modes they appear in are presented throughout this manual.



WARNING: Prior to diving with the Elite T3, you must also read and understand the AERIS Dive Computer Safety and Reference Manual, Doc. No. 12-7203, which provides Important Warnings and Safety Recommendations as well as general product information.

SURFACE SEQUENCE AND OPERATING MODES

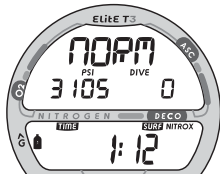

Fig. 15A - NORM SURF MAIN



Fig. 15B - GAUG SURF MAIN

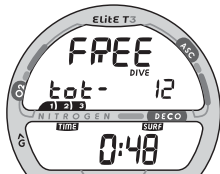

Fig. 15C - FREE SURF MAIN

OPERATING MODES

As described previously, the Elite T3 features 3 Operating Modes -

- NORM - for Normal Air or Nitrox dives
- GAUG - for dives with no Nitrogen/Oxygen calculations
- FREE - for dives with no SCUBA

△ REMINDER: Once a dive is made in GAUG Mode, the Elite T3 is locked into that Mode for 24 hours after the dive.

SURFACE MODE

After activation and while the default Surface Main screen is displayed, pressing and holding the M button for 2 seconds steps through the operating mode Surface Main screens.

Fig. 15 - NORM MAIN >> GAUG MAIN >> FREE MAIN

- The Operating Mode selected (NORM, GAUG, or FREE) will remain on display for 2 hours until a dive is made or another Operating Mode is selected.

If a dive has been conducted within the past 24 hours, the SURF MAIN screen for that mode will be displayed until changed. At any time while operating in Surface Modes, the Elite T3 will enter Dive Mode upon descent to 5 FT (1.5 M).

The Elite T3 will enter POST DIVE SURFACE MODE following a dive upon ascent to 4 FT (1.2 M). The Surface Interval Time colon will flash during the first 10 minutes after a NORM/GAUG dive (Fig. 16), or first 1 minute after a FREE dive.

During the first 2 hours after a dive, the SURF MAIN screen for the Operating Mode selected prior to the dive (NORM, GAUG, or FREE) remains on display as the Default SURF MAIN screen.

NORM SURF MAIN, information provided includes (Fig. 17):

- > Graphic NORM alternating with the Altitude Level graphic SEA (or EL2 through EL13) and WET (if the unit is wet), each On 3 seconds then 1/4 second blank.
- > Battery icon if an Elite T3 Low Battery Warning Condition exists, flashing if Too Low
- > Tank Pressure and symbol PSI (or BAR), if the Receiver is successfully Linked with an active Transmitter.
- > Symbol DIVE and Number of that dive (0 if no dive has been made yet).
- > Symbols TIME and SURF, and Surface Interval (hr:min).
- > NITROX symbol, if any GAS is set for a Nitrox dive.
- > Tank 1 icon representing GAS 1, which is the default start Gas and default Gas 10 minutes after a dive.
- > NIBG if any after a NORM or FREE dive.
- > O2BG if any after a NORM Nitrox dive.



Fig. 16 - NORM SURF MAIN (post dive, unit wet)

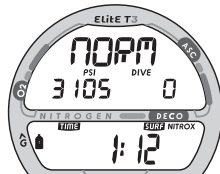

Fig. 17 - NORM SURF MAIN (no dive made yet, dry)

NORM SURF MAIN - Button Operations:

- Pressing the S button will activate the Smartglo Backlight.
- Pressing and releasing the A button repeatedly (< 2 seconds each time) will step through the NORM Surface Sequence -

NORM SURF MAIN > NORM SURF ALT > PLAN > FLY > SAT > LOG > HISTORY.

- Depressing both the A and S buttons simultaneously for 2 seconds will access the SET Menu (F > A > U > T) and an Elite T3 Serial Number display.

SURF MAIN > SET FO2 > SET Alarms > SET Utilities > SET TIME > SN

- Pressing and holding the M button for 2 seconds will access the GAUG SURF MAIN screen, then another 2 second press will access the FREE SURF MAIN screen.

NORM SURF > GAUG SURF > FREE SURF

- Depressing the S button for 2 seconds while viewing the NORM SURF screen will activate the Elite T3's Receiver and access a series of screens that will indicate the Status of the Batteries and Pressures of the Tanks in use. Transmitter Battery Status is not displayed for TMT 2 and 3 if TMT 2-3 USE is set for Buddy Pressure Check.
- If a Transmitter (abbreviated TMT) is not active and linked to the Elite T3, the message NotAvAil (Not Available) will appear.
- Each screen will be displayed for 3 seconds. Elite T3 Battery Status, then TMT 1 Battery Status and Tank Pressure, then TMT 2 Battery Status and Tank Pressure, then TMT 3 Battery Status and Tank Pressure, then revert to SURF MAIN

Elite T3 BATTERY STATUS, information includes (Fig. 18):

- > Graphics Elite T3 and bAt
- > Graphic Good (or Lo)
- > Battery icon, if a Low Battery Warning Condition exists.
Flashing if an Alarm Condition exists.

Transmitters (referred to as TMTs) that are active and Linked will transmit signals conveying Tank Pressure and Battery Status for display on the Status screens. If a TMT is not active or active but not Linked, the Status screen(s) will display Not Available.

TRANSMITTER STATUS, information includes (Fig. 19 A/B):

- > Graphics TMT1 (then TMT2 and TMT3), identifying the reporting Transmitter, and bAt.
- > Graphic Good (or Lo), or NotAvAil (if not active/linked)
- > Battery icon, if a Low Battery Warning Condition exists.
Flashing if an Alarm Condition exists.
- > Tank Pressure for the TMT reporting and symbol PSI (or BAR).

△ REMINDER: If TMT 2-3 USE is set for BUD (Buddy Pressure Check), TMT2 and TMT3 screens will not display Battery Status (only Pressure).

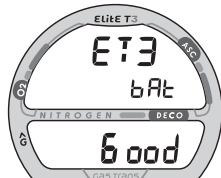

Fig. 18 - Elite T3 Battery Good

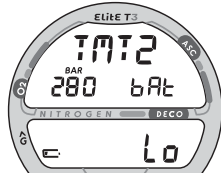

Fig. 19A - TMT1 Battery Low



Fig. 19B - TMT3 Not Available

GAUG and FREE Operating Modes are also described in separate sections of this manual.

SET MODES

Unless noted otherwise, features set apply to all Operating Modes (NORM, GAUG, and FREE. FREE Dive Mode also has several settings that do not affect NORM and GAUG Modes.

SURF MAIN > SET F > SET A > SET U > SET T > Elite T3 SN

Access and step through of the sequence is gained by repeated simultaneous 2 second presses of the A and S buttons.

Alarms (Set A), Utilities (Set U), and Time (Set T) Set Points can also be set/changed using the PC Settings Upload program. FO2 (Set F) entries must be made using only the push buttons.

SET F GROUP (FO2)

Set F Sequence:

SET F > FO2 GAS1 > FO2 GAS2 > FO2 GAS3 > FO2 Default.

- > Depressing the A and S buttons simultaneously for 2 seconds while the NORM or GAUG SURF MAIN screen is displayed will access SET F identified by the graphic SETF (Fig. 20).
- > Pressing and releasing the A button momentarily (< 2 seconds) while SET F is displayed will advance to SET FO2 GAS 1 with the Set Point flashing.

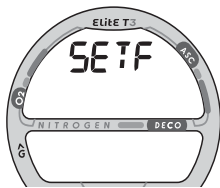

Fig. 20 - Set F (FO2)

Setting FO2 for NORM Nitrox Dives:

For each value of FO2, the Maximum Operating Depth (MOD) that can be achieved for the PO2 Alarm Set Point limit previously set, will be displayed.

When the FO2 50% DEFAULT is set ON and FO2 GAS 1 is set for a numerical value, 10 minutes on the surface after that dive, the FO2 for GAS 1 will be displayed as 50 and further dives will be calculated based on 50% O2 for oxygen calculations and 21% O2 for Nitrogen calculations (79% Nitrogen) unless the FO2 for GAS 1 is set before the dive.

FO2 for GAS 1 continues to reset to the FO2 50% DEFAULT after subsequent repetitive dives until 24 hours elapse after the last dive, or the FO2 50% DEFAULT is turned OFF in the Set FO2 50% DEFAULT ON/OFF MODE.

When the FO2 50% DEFAULT is set OFF, the Elite T3 will remain set at the last FO2 GAS 1 Set Points for that series of repetitive dives.

The default FO2 for GAS 1 each new dive Period is AIR.

When FO2 for GAS 1 is set for AIR, the calculations are the same as when it is set to an FO2 of 21%. When FO2 for GAS 1 is set to AIR, it remains set for AIR until it is set for a numerical FO2 value (21 to 50%).

When FO2 is set only to AIR, the O2 Bar Graph is not displayed at any time during a dive or on the surface. PO2 values and/or warnings will not be displayed during the dive.

FREE Dive nitrogen calculations are based on AIR and not affected by these FO2 Settings.

Maximum Operating Depths affected by the PO2 limit set will not be displayed when FO2 for GAS 1 is set to AIR.

Internally, the Elite T3 keeps track of the oxygen loading so that if FO2 for GAS 1 is subsequently set for a numerical value, the oxygen loading for previous AIR dives will be accounted for in the next Nitrox dive (during that dive period and series of repetitive dives).

Once FO2 GAS 1 is set for a numerical value (21 to 50%) and a dive is made, the AIR option is disabled until 24 hours elapse after the last dive. The AIR option will not be displayed in Set FO2 GAS 1 until a full 24 hour Surface Interval has elapsed.

If FO2 for GAS 1 is set for 21%, it will remain set for 21% for that series of dives until set for a higher numerical value.

If the FO2 50% DEFAULT is set OFF, FO2 for GAS 2 and 3 will remain at their respective Set Points previously selected until they are changed. If the FO2 50% DEFAULT is set ON, FO2 for GAS 2 and 3 will Default to 50% after the dive.

The Elite T3 is programmed to prevent FO2 for GAS 2 and 3 from being set at values lower than the FO2 Set Point for GAS 1. GAS 2 and 3 can only be set to values equal to or higher than the FO2 Set Points of GAS 1 and 2, respectively.

When setting FO2 for GAS 2 and 3, the lowest values available will be the Set Point of the previous Gas set (e.g., if FO2 GAS 1 is set for 32%, FO2 for GAS 2 can only be set at values from 32 to 100%. Likewise, FO2 for GAS 3 will depend on the setting for GAS 2.

SET FO2 GAS 1, information includes:

- > Graphic GAS1
 - > PO2 Alarm Set Point with graphic PO2, if Nitrox
 - > Symbol FO2 and FO2 Set Point value, flashing
 - > Tank 1 icon representing GAS 1
 - > Symbol NITROX (if set for a numerical value).
 - > Max Depth allowed for the PO2 Alarm Set (if 21 to 50%)
- Depressing and holding the S button while the Set Point is flashing will scroll the Set Points from AIR (Fig. 21) to 21 through 50% in 1% increments, at a rate of 8 per second.
 - Hint: The scroll will stop when the button is released, or momentarily at 32% (even if the button is held depressed).
 - Pressing and holding the S button will resume the scroll from 32 (Fig. 22) through 50%, then stop at AIR (or 21%).
 - Pressing and releasing the S button will advance FO2 in increments of 1% per press of the button.
 - Pressing and releasing the A button momentarily (< 2 seconds) will save the setting and/or advance to SET FO2 GAS 2 with the Set Point flashing.
 - Pressing and releasing the A button repeatedly (< 2 seconds each) will step through the other SET F screens.
 - Depressing the A and S buttons simultaneously for 2 seconds will save the setting and revert to the SET F screen.
 - Depressing the M button for 2 seconds or if no button action for 2 minutes will revert to NORM or GAUG SURF.

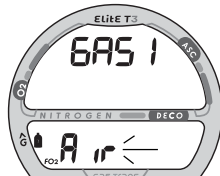

Fig. 21 - Set FO2 GAS 1 (AIR)

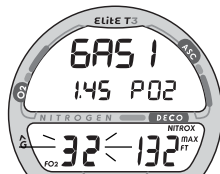

Fig. 22 - Set FO2 GAS 1 (Nitrox)

SET FO2 GAS 2, information includes:

- > Graphic GAS2
 - > PO2 Alarm Set Point with graphic PO2
 - > Symbol FO2 and FO2 Set Point value, flashing
 - > Tank 2 icon representing GAS 2
 - > Symbol NITROX (if set for a numerical value).
 - > Max Depth allowed for the PO2 Alarm Set (if 21 to 100%)
- Depressing the S button while the FO2 Set Point is flashing will scroll the Set Point from AIR to 21 through 100% in 1% increments, at a rate of 8 per second.
 - The scroll will start at the FO2 GAS 1 Set Point and stop when the button is released, or momentarily at 50% (Fig. 23), then 80% (even if the button is held depressed).
 - Depressing the S button will resume the scroll through 100%, then stop at AIR (or 21 or the GAS 1 setting).
 - Pressing and releasing the S button (< 2 seconds) will advance FO2 in increments of 1% per press of the button.
 - Pressing and releasing the A button momentarily (< 2 seconds) will save the setting and/or advance to SET FO2 GAS 3 with the Set Point flashing.
 - Pressing and releasing the A button momentarily and repeatedly (< 2 seconds) will step through the other SET F screens.
 - Depressing the A and S buttons simultaneously for 2 seconds will save the setting and revert to the SET F screen.
 - Depressing the M button for 2 seconds or if no button action for 2 minutes operation will revert to the SURF MAIN screen.

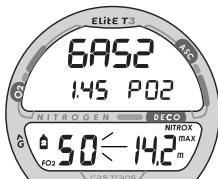

Fig. 23 - Set FO2 GAS 2
(50% O2)

SET FO2 GAS 3 information includes:

- > Graphic GAS3
 - > PO2 Alarm Set Point with graphic PO2
 - > Symbol FO2 and FO2 Set Point value, flashing
 - > Tank 3 icon representing GAS 3
 - > Symbol NITROX (if set for a numerical value).
 - > Max Depth allowed for the PO2 Alarm Set (if 21 to 100%)
-
- Depressing the S button while the FO2 Set Point is flashing will scroll the Set Point from AIR to 21 through 100% (Fig. 24) in 1% increments, at a rate of 8 per second.
 - The scroll will start at the FO2 GAS 2 Set Point and stop when the button is released, or momentarily at 50% then 80% (even if the button is held depressed).
 - Depressing and holding the S button will resume the scroll through 100%, then stop at AIR (or 21 or the GAS 2 setting).
 - Pressing and releasing the S button (< 2 seconds) will advance FO2 in increments of 1% per press of the button.
 - Pressing and releasing the A button momentarily (< 2 seconds) will save the setting and/or advance to SET FO2 50% DEFAULT with the Set Point flashing.
 - Pressing and releasing the A button repeatedly (< 2 seconds each) will step through the other SET F screens.
 - Depressing the A and S buttons simultaneously for 2 seconds will save the setting and revert to the SET F screen.
 - Depressing and holding the M button for 2 seconds or if no button is pressed for a period of 2 minutes operation will revert to the SURF MAIN screen.

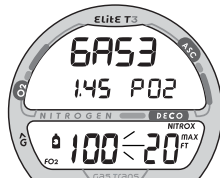

Fig. 24 - Set FO2 GAS 3
(100% O2)

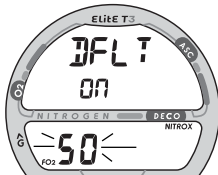

Fig. 25 - Set FO2 Default

SET FO2 50% DEFAULT information includes (Fig. 25):

- > Graphics DFLT and 50
 - > Set Point graphic OFF (or ON), flashing.
 - > Symbols FO2 and NITROX.
- Pressing and releasing the S button (< 2 seconds) will toggle between OFF and ON.
 - Pressing and releasing the A button (< 2 seconds) will save the setting and revert to the SET F screen.
 - Depressing the M button for 2 seconds or if no button is pressed for a period of 2 minutes operation will revert to the NORM or GAUG SURF MAIN screen.

SET A GROUP (NORM/GAUG ALARMS)

Set A Sequence:

SET A > Audible > Depth > EDT > NIBG > DTR > Turn Pressure > End Pressure > PO2

- > The SET A Group can also be set/changed using the PC Settings Upload program.
- > SET A items do not strike Alarms in FREE Dive Mode.
- > SET A Settings remain at the values set until changed.
- > Depressing the A and S buttons simultaneously for 4 seconds while NORM or GAUG SURF MAIN is displayed will access SET A identified by the graphic SETA (Fig. 26).



Fig. 26 - Set A (Alarms)

- > Pressing and releasing the A button momentarily (< 2 seconds) while SET A is displayed will advance to SET AUDIBLE ALARM with the Set Point flashing.

SET AUDIBLE ALARM

This option allows the Audible Alarms and the associated red warning LED function to be disabled.

Some cautionary situations will cause the Audible Alarm to sound and the LED to flash even if this feature is set to OFF.

SET AUDIBLE ALARM information includes (Fig. 27):

- > Graphic AUD
 - > Set Point graphic ON (or OFF), flashing.
- Pressing and releasing the S button (< 2 seconds) will toggle between ON and OFF.
 - Pressing and releasing the A button momentarily (< 2 seconds) will save the setting and/or advance to the SET DEPTH ALARM screen with the Set Point flashing.
 - Pressing and releasing the A button repeatedly (< 2 seconds each) will step through the other SET A screens.
 - Depressing the A and S buttons simultaneously for 2 seconds will save the setting and revert to the SET A screen.
 - Depressing the M button for 2 seconds or if no button action for 2 minutes operation will revert to the NORM or GAUG SURF MAIN screen.



Fig. 27 - Set Audible Alarm

SET DEPTH ALARM information includes (Fig. 28):

- > Graphic DPTH
 - > Symbols MAX and FT (or M)
 - > Set Point graphic value, flashing.
-
- Pressing and releasing the S button momentarily (< 2 seconds) will step through the Set Points from 30 to 330 FT (10 to 100 M) in 10 FT (1 M) increments at a rate of 1 Set Point per press of the button.
 - Depressing and holding the S button will scroll through the Set Points at a rate of 4 Set Points per second until it is released.
 - Pressing and releasing the A button momentarily (< 2 seconds) will save the setting and/or advance to the SET EDT (Elapsed Dive Time) ALARM screen with the Set Point flashing.
 - Pressing and releasing the A button momentarily and repeatedly (< 2 seconds each time) will step through the other SET A screens.
 - Pressing the A and S buttons simultaneously for 2 seconds will save the setting and revert to the SET A screen.
 - Depressing and holding the M button for 2 seconds or if no button is pressed for a period of 2 minutes operation will revert to the NORM or GAUG SURF MAIN screen.

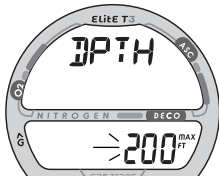

Fig. 28 - Set Depth Alarm

FREE Mode has separate Depth Alarms.

SET EDT (ELAPSED DIVE TIME) ALARM

Information includes (Fig. 29):

- > Graphic EDT
 - > Symbols DIVE and TIME.
 - > Set Point value (hr:min), flashing.
-
- Pressing and releasing the S button momentarily (< 2 seconds) will increase the Set Point from 0:10 to 3:00 (hours:minutes) in 5 minute (:05) increments.
 - Depressing the S button will scroll through the Set Points at a rate of 4 Set Points per second until it is released.
 - Pressing and releasing the A button momentarily (< 2 seconds) will save the setting and/or advance to the SET NIBG (Nitrogen Loading Bar Graph) ALARM screen with the Set Point flashing.
 - Pressing and releasing the A button repeatedly (< 2 seconds each) will step through the other SET A screens.
 - Depressing the A and S buttons simultaneously for 2 seconds will save the setting and revert to the SET A screen.
 - Depressing the M button for 2 seconds or if no button is pressed for 2 minutes operation will revert to the NORM or GAUG SURF MAIN screen.

FREE Mode has a separate EDT Alarm.

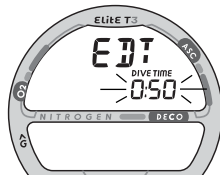

Fig. 29 - Set EDT Alarm

Setting the NIBG Alarm to activate before the Elite T3 enters DECO is highly recommended.

SET NIBG (NITROGEN LOADING BAR GRAPH) ALARM

Information includes (Fig. 30):

- > Graphic NIBG
 - > NIBG Set Point (segments), flashing.
- Pressing and releasing the S button momentarily (< 2 seconds) will decrease the Set Point from All 5 segments (Deco) to 1 in increments of 1 segment.
 - Depressing the S button will scroll through the Set Points at a rate of 4 Set Points per second until it is released.
 - Pressing and releasing the A button momentarily (< 2 seconds) will save the setting and/or advance to the SET DTR (Dive Time Remaining) ALARM screen with the Set Point flashing.
 - Pressing and releasing the A button repeatedly (< 2 seconds each) will step through the other SET A screens.
 - Depressing the A and S buttons simultaneously for 2 seconds will save the setting and revert to the SET A screen.
 - Depressing the M button for 2 seconds or if no button is pressed for a period of 2 minutes operation will revert to the NORM or GAUG SURF MAIN screen.

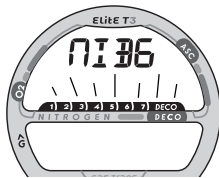

Fig. 30 - Set NIBG Alarm

FREE Mode has a separate NIBG Alarm.

SET DTR (DIVE TIME REMAINING) ALARM

Information includes (Fig. 31):

- > Graphic DTR
 - > Symbols AIR, TIME, NDC, and O₂.
 - > Set Point value, flashing.
-
- Pressing and releasing the S button momentarily (< 2 seconds) will increase the Set Point from 0:00 to 0:20 (:minutes) in 1 minute (0:01) increments.
 - Depressing the S button will scroll through the Set Points at a rate of 4 Set Points per second until it is released.
 - Pressing and releasing the A button momentarily (< 2 seconds) will save the setting and/or advance to the SET TURN PRESSURE ALARM screen with the Set Point flashing.
 - Pressing and releasing the A button momentarily and repeatedly (< 2 seconds each) will step through the other SET A screens.
 - Depressing the A and S buttons simultaneously for 2 seconds will save the setting and revert to the SET A screen.
 - Depressing the M button for 2 seconds or if no button is pressed for a period of 2 minutes operation will revert to the NORM or GAUG SURF MAIN screen.

Whichever Time (No Decompression, O₂, or Air Time Remaining) decreases to the Alarm Set Point will activate the Alarm.

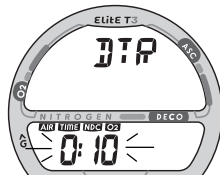

Fig. 31 - Set DTR Alarm

SET TURN PRESSURE ALARM (for Transmitter 1 only)

Information includes (Fig. 32):

- > Graphic TURN
 - > Set Point OFF or a numeric value, flashing.
 - > Symbol PSI (or M)
-
- Pressing and releasing the S button momentarily (< 2 seconds) will step through the Set Points from OFF to 1000 to 3000 PSI (70 to 205 BAR) in 250 PSI (5 BAR) increments.
 - Depressing the S button will scroll through the Set Points at a rate of 4 Set Points per second until it is released.
 - Pressing and releasing the A button momentarily (< 2 seconds) will save the setting and/or advance to the SET END PRESSURE ALARM screen with the Set Point flashing.
 - Pressing and releasing the A button repeatedly (< 2 seconds each) will step through the other SET A screens.
 - Depressing the A and S buttons simultaneously for 2 seconds will save the setting and revert to the SET A screen.
 - Depressing the M button for 2 seconds or if no button is pressed for a period of 2 minutes operation will revert to the NORM or GAUG SURF MAIN screen.

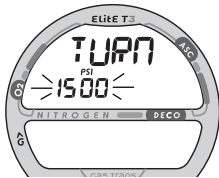

Fig. 32 - Set Turn Alarm

SET END PRESSURE ALARM information includes (Fig. 33):

- > Graphic END
 - > Set Point numeric value, flashing.
 - > Symbol PSI (or M)
- Pressing and releasing the S button momentarily (< 2 seconds) will increase the Set Point from 300 to 1500 PSI (20 to 105 BAR) in 100 PSI (5 BAR) increments.
 - Depressing the S button will scroll through the Set Points at a rate of 4 Set Points per second until it is released.
 - Pressing and releasing the A button momentarily (< 2 seconds) will save the setting and/or advance to the SET PO2 ALARM screen with the Set Point flashing.
 - Pressing and releasing the A button repeatedly (< 2 seconds each) will step through the other SET A screens.
 - Depressing the A and S buttons simultaneously for 2 seconds will save the setting and revert to the SET A screen.
 - Depressing the M button for 2 seconds or if no button is pressed for a period of 2 minutes operation will revert to the NORM or GAUG SURF MAIN screen.

The END PRESSURE Alarm will activate when Pressure in the Tank (TMT 1, 2, or 3) being used at the time decreases to the Alarm Set Point.

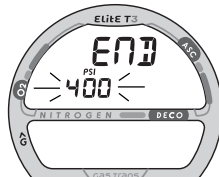

Fig. 33 - Set End Alarm

Setting the PO2 Alarm to activate before reaching the Max allowed limit of 1.60 ATA is highly recommended.

SET PO2 ALARM information includes (Fig. 34):

- > Graphics PO2 and AtA
 - > Set Point value, flashing.
 - > Symbol MAX
- Pressing and releasing the S button momentarily (< 2 seconds) will increase the Set Point from 1.20 (ATA) to 1.60 (ATA) in .10 (ATA) increments.
 - Depressing the S button will scroll through the Set Points at a rate of 4 Set Points per second until it is released.
 - Pressing and releasing the A button momentarily (< 2 seconds) will save the setting and/or advance to the SET A screen.
 - Depressing the A and S buttons simultaneously for 2 seconds will save the setting and revert to the SET A screen.
 - Depressing the M button for 2 seconds or if no button is pressed for a period of 2 minutes operation will revert to the NORM or GAUG SURF MAIN screen.

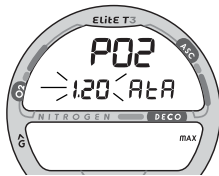

Fig. 34 - Set PO2 Alarm

SET U GROUP (UTILITIES)

Set U Sequence:

SET U > Wet Activation > Units > Safety Stop > Conservative Factor > Backlight Duration > Sampling Rate > TMT 1 > TMT 2-3 USE > TMT 2 (or BUD 1) > TMT 3 (or BUD 2).

- > The SET U Group can also be set/changed using the PC Settings Upload program.
- > SET U Settings remain at the values set until changed.
- > FREE Mode utilizes the settings for Wet Activation, Units, and Backlight Duration. It has a separate Sampling Rate fixed at a 1 second interval not affected by the SET U setting.
- Depressing the A and S buttons simultaneously for 6 seconds while the NORM or GAUG SURF MAIN screen is displayed, will access SET U identified by the graphic SETU (Fig. 35).
- Pressing and releasing the A button momentarily (< 2 seconds) while SET U is displayed will advance to SET WET ACTIVATION with the Set Point flashing.

TMT is the abbreviation used for Transmitter.

BUD is the abbreviation used for Buddy.

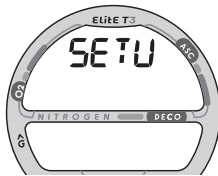

Fig. 35 - SET U (Utilities)

SET WET ACTIVATION information includes (Fig. 36):

- > Graphic WET
 - > Set Point graphic ON (or OFF) flashing.
-
- Pressing and releasing the S button will toggle between ON and OFF.
 - Pressing and releasing the A button momentarily (< 2 seconds) will save the setting and/or advance to the SET UNITS screen with the Set Point flashing.
 - Pressing and releasing the A button repeatedly (< 2 seconds each) will step through the other SET U screens.
 - Depressing the A and S buttons simultaneously for 2 seconds will save the setting and revert to the SET U screen.
 - Depressing the M button for 2 seconds or if no button is pressed for a period of 2 minutes operation will revert to the NORM or GAUG SURF MAIN screen.

HINT: To change this setting while operating in FREE Mode, first access the NORM SURF Mode.

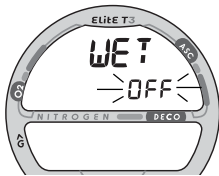

Fig. 36 - Set Wet Activation

SET UNITS information includes (Fig. 37):

- > Graphic UNIT
 - > Set Point symbols/graphics PSI, F, and FT (or BAR, C, and M), flashing.
-
- Pressing and releasing the S button will toggle between Imperial (F, FT, PSI) and Metric (C, M, BAR).
 - Pressing and releasing the A button momentarily (< 2 seconds) will save the setting and/or advance to the SET SAFETY STOP screen with the Time Set Point flashing.
 - Pressing and releasing the A button repeatedly (< 2 seconds each) will step through the other SET U screens.
 - Depressing the A and S buttons simultaneously for 2 seconds will save the setting and revert to the SET U screen.
 - Depressing the M button for 2 seconds or if no button is pressed for a period of 2 minutes operation will revert to the NORM or GAUG SURF MAIN screen.

HINT: To change this setting while operating in FREE Mode, first access the NORM SURF Mode.

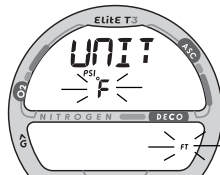

Fig. 37 - Set Units

SET NORM SAFETY STOP information includes (Fig. 38):

- > Graphic SAFE
 - > Symbols STOP and TIME.
 - > Safety Stop Time Set Point, flashing.
 - > Safety Stop Depth Set Point and symbol FT (or M).
- Pressing and releasing the S button momentarily (< 2 seconds each) will step through the Stop Time Set Points of OFF, 3:00, and 5:00 (minutes:seconds).
 - Pressing and releasing the A button momentarily (< 2 seconds) will save the Stop Time setting and the Stop Depth Set Point will flash, or if Stop Time is set OFF advance to the SET CONS (Conservative Factor) screen with the Set Point flashing.
 - Pressing and releasing the S button momentarily (< 2 seconds each) will step through the Stop Depth Set Points of 10, 15, and 20 FT (or 3, 4, 5, and 6 M).
 - Pressing and releasing the A button momentarily (< 2 seconds) will save the Safety Stop settings and/or advance to the SET CONS screen with the Set Point flashing.
 - Pressing the A button repeatedly (< 2 seconds) will step through the other SET U screens.

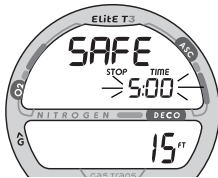

Fig. 38 - Set Safety Stop

- Depressing the A and S buttons simultaneously for 2 seconds will save the settings and revert to the SET U screen.
- Depressing the M button for 2 seconds or if no button is pressed for a period of 2 minutes operation will revert to the NORM or GAUG SURF MAIN screen.

SET CONSERVATIVE FACTOR information includes (Fig. 39):

- > Graphic CONS
 - > Set Point ON (or OFF), flashing.
 - > Symbols TIME and NDC.
-
- Pressing and releasing the S button (< 2 seconds) will toggle between ON and OFF.
 - Pressing and releasing the A button momentarily (< 2 seconds) will save the setting and/or advance to the SET BACKLIGHT DURATION screen with the Set Point flashing.
 - Pressing and releasing the A button repeatedly (< 2 seconds each) will step through the other SET U screens.
 - Depressing the A and S buttons simultaneously for 2 seconds will save the setting and revert to the SET U screen.
 - Depressing the M button for 2 seconds or if no button is pressed for a period of 2 minutes operation will revert to the NORM or GAUG SURF MAIN screen.

△ NOTE: When the Conservative Factor is set ON, the No Decompression Limit dive times are reduced to values equivalent to those that would be available at the next higher 3000 foot (915 meter) Altitude. Refer to the tables on Pages 150/151.



Fig. 39 - Set Conservative Factor

SET BACKLIGHT DURATION information includes (Fig. 40):

- > Graphic GLOW.
 - > Symbol TIME.
 - > Set Point, flashing.
- Pressing and releasing the S button momentarily (< 2 seconds each) will step through the Set Points of :00, :05, and :10 (seconds).
 - Pressing and releasing the A button momentarily (< 2 seconds) will save the setting and/or advance to the SET SAMPLING RATE screen with the Set Point flashing.
 - Pressing and releasing the A button repeatedly (< 2 seconds each) will step through the SET U screens.
 - Depressing the A and S buttons simultaneously for 2 seconds will save the setting and revert to the SET U screen.
 - Depressing the M button for 2 seconds or if no button is pressed for a period of 2 minutes operation will revert to the NORM or GAUG SURF MAIN screen.

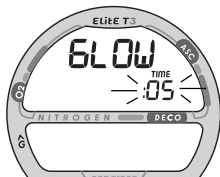

Fig. 40 - Set Backlight Duration

HINT: To change the Backlight Duration while operating in FREE Mode, first access the NORM SURF Mode.

SET SAMPLING RATE information includes (Fig. 41):

- > Graphic SAMP
 - > Symbol TIME.
 - > Set Point, flashing.
- Pressing and releasing the S button momentarily (< 2 seconds) will step through the Set Points of :02, :15, :30, :60 (seconds).
 - Depressing the S button will scroll through the Set Points at a rate of 4 Set Points per second until it is released.
 - Pressing and releasing the A button momentarily (< 2 seconds) will save the setting and/or advance to the SET TMT 1 screen with the Set Point flashing.
 - Pressing and releasing the A button repeatedly (< 2 seconds each) will step through the other SET U screens.
 - Depressing the A and S buttons simultaneously for 2 seconds shall save the setting and revert to the SET U screen.
 - Depressing the M button for 2 seconds or if no button is pressed for a period of 2 minutes operation will revert to the NORM or GAUG SURF MAIN screen.

△ NOTE: FREE Mode has a separate fixed Sampling Rate of 1 second.

SAMPLING RATE is the frequency (time interval) at which data is sampled and stored in memory for subsequent download to the AERIS Computer Interface program.

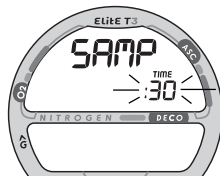

Fig. 41 - Set Sampling Rate

TMT is the abbreviation for Transmitter.

BUD is the abbreviation for Buddy.

SET TMT 1 information includes (Fig. 42):

- > Graphics TMT1 and ON (or OFF) flashing.
 - > Set Point (Transmitter's Serial Number (Link Code)).
- Pressing and releasing the S button momentarily (< 2 seconds) will toggle between ON and OFF.
 - Pressing and releasing the A button momentarily (< 2 seconds) will accept the ON/OFF selection.
 - If OFF is selected, SET TMT 2-3 USE , SET TMT 2 (or BUD 1), and TMT 3 (or BUD 2) will be bypassed and operation will revert to the SET U screen.
 - If ON is selected, the first (left) digit of the Code will flash.
 - Pressing and releasing the S button repeatedly (< 2 seconds each) will increase the First Digit from 0 to 9 in increments of 1.
 - Depressing the S button will scroll through the Set Points at a rate of 4 per second.
 - Pressing and releasing the A button (< 2 seconds) will accept the First Digit of the Code and/or advance to the Second Digit which will be flashing.
 - Pressing and releasing the S button will increase the Second Digit from 0 to 9 in increments of 1.
 - Depressing the S button will scroll through the Set Points at a rate of 4 per second.

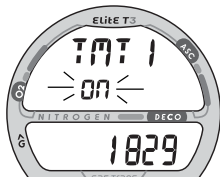

Fig. 42 - Set TMT 1

- Pressing and releasing the A button (< 2 seconds) will accept the Second Digit of the Code and/or advance to the Third Digit which will be flashing.
- Pressing and releasing the S button repeatedly (< 2 seconds each) will increase the Third Digit from 0 to 9 in increments of 1.
- Depressing the S button will scroll through the Set Points at a rate of 4 per second.
- Pressing and releasing the A button (< 2 seconds) will accept the Third Digit of the Code and/or advance to the Fourth Digit which will be flashing.
- Pressing and releasing the S button repeatedly (< 2 seconds each) will increase the Fourth Digit from 0 to 9 in increments of 1.
- Depressing the S button will scroll through the Set Points at a rate of 4 per second.
- Pressing and releasing the A button (< 2 seconds) will accept the Fourth Digit of the Code and/or advance to the Fifth Digit which will be flashing.
- Pressing and releasing the S button repeatedly (< 2 seconds each) will increase the Fifth Digit from 0 to 9 in increments of 1.
- Depressing the S button will scroll through the Set Points at a rate of 4 per second.
- Pressing and releasing the A button will accept the Fifth Digit of the Code and/or advance to the Sixth Digit which will be flashing.
- Pressing and releasing the S button repeatedly (< 2 seconds each) will increase the Sixth Digit from 0 to 9 in increments of 1.
- Depressing the S button will scroll through the Set Points at a rate of 4 per second.
- Pressing and releasing the A button (< 2 seconds) will accept the TMT 1 Link Code and/or advance to SET TMT 2-3 USE with the Set Point flashing.
- Depressing the A and S buttons simultaneously for 2 seconds will save the setting and revert back to the SET U screen.

SET TMT 2-3 USE information includes (Fig. 43):

- > Graphics TMT and 2-3 USE.
 - > Set Point graphic SELF (or bud) flashing.
- Pressing and releasing the S button momentarily (< 2 seconds) will toggle between SELF and bud.
 - Pressing and releasing the A button momentarily (< 2 seconds) will accept the setting and/or advance to SET TMT 2 (or BUD 1) with ON or OFF flashing.
 - Depressing the A and S buttons simultaneously for 2 seconds will save the setting and revert to the SET U screen.
 - Depressing the M button for 2 seconds or if no button is pressed for a period of 2 minutes operation will revert to the NORM or GAUG SURF MAIN screen.

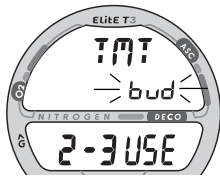

Fig. 43 - Set TMT 2-3 Use

When set for SELF, TMT 2 and TMT 3 are associated with Transmitters to be used by the diver using the Elite T3 for Gas Switching.

When set for BUD, TMT 1 is associated with the user of the Elite T3 and TMT 2 and TMT 3 are associated with Transmitters to be used by other divers (Buddies) whose Pressure can be checked by the user of the Elite T3.

SET TMT 2 (or BUD 1) information includes (Fig. 44):

- > Graphics TMT2 (or BUD1) and ON (or OFF) flashing.
 - > Set Point (Transmitter's Serial Number (Link Code)).
- Pressing and releasing the S button momentarily (< 2 seconds) will toggle between ON and OFF.
 - Pressing and releasing the A button momentarily (< 2 seconds) will accept the ON/OFF selection.
 - If OFF is selected, SET TMT 3 (or BUD 2) will be bypassed and the operation will revert to the SET U screen.
 - If ON is selected, the first (left) digit of the Code will flash.
 - Pressing and releasing the S button repeatedly (< 2 seconds each) will increase the First Digit from 0 to 9 in increments of 1.
 - Depressing the S button will scroll through the Set Points at a rate of 4 per second.
 - Pressing and releasing the A button (< 2 seconds) will accept the First Digit of the Code and/or advance to the Second Digit which will be flashing.
 - Pressing and releasing the S button will increase the Second Digit from 0 to 9 in increments of 1.
 - Depressing the S button will scroll through the Set Points at a rate of 4 per second.
 - Pressing and releasing the A button (< 2 seconds) will accept the Second Digit of the Code and/or advance to the Third Digit which will be flashing.

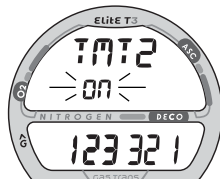

If TMT 2-3 USE is set for
SELF (Gas Switching)

- OR -

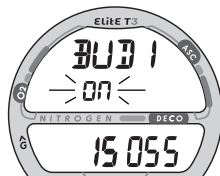

If TMT 2-3 USE is set for
Buddy Pressure Check

Fig. 44 - Set TMT 2 or BUD 1

- Pressing and releasing the S button repeatedly (< 2 seconds each) will increase the Third Digit from 0 to 9 in increments of 1.
- Depressing the S button will scroll through the Set Points at a rate of 4 per second.
- Pressing and releasing the A button (< 2 seconds) will accept the Third Digit of the Code and/or advance to the Fourth Digit which will be flashing.
- Pressing and releasing the S button repeatedly (< 2 seconds each) will increase the Fourth Digit from 0 to 9 in increments of 1.
- Depressing the S button will scroll through the Set Points at a rate of 4 per second.
- Pressing and releasing the A button (< 2 seconds) will accept the Fourth Digit of the Code and/or advance to the Fifth Digit which will be flashing.
- Pressing and releasing the S button repeatedly (< 2 seconds each) will increase the Fifth Digit from 0 to 9 in increments of 1.
- Depressing the S button will scroll through the Set Points at a rate of 4 per second.
- Pressing and releasing the A button will accept the Fifth Digit of the Code and/or advance to the Sixth Digit which will be flashing.
- Pressing and releasing the S button repeatedly (< 2 seconds each) will increase the Sixth Digit from 0 to 9 in increments of 1.
- Depressing the S button will scroll through the Set Points at a rate of 4 per second.
- Pressing and releasing the A button (< 2 seconds) will accept the TMT 2 (or BUD 1) Link Code and/or advance to SET TMT 3 (or BUD 2) with ON or OFF flashing.
- Depressing the A and S buttons simultaneously for 2 seconds will save the setting and revert to the SET U screen.

SET TMT 3 (or BUD 2) information includes (Fig. 45):

- > Graphics TMT3 (or BUD2), and ON (or OFF) flashing.
 - > Set Point (Transmitter's Serial Number (Link Code)).
-
- Pressing and releasing the S button momentarily (< 2 seconds) will toggle between ON and OFF.
 - Pressing and releasing the A button momentarily (< 2 seconds) will accept the ON/OFF selection.
 - If OFF is selected, operation reverts to the SET U screen.
 - If ON is selected, the first (left) digit of the Code will flash.
 - Pressing and releasing the S button repeatedly (< 2 seconds each time) will increase the First Digit from 0 to 9 in increments of 1.
 - Depressing the S button will scroll through the Set Points at a rate of 4 per second.
 - Pressing and releasing the A button (< 2 seconds) will accept the First Digit of the Code and/or advance to the Second Digit which will be flashing.
 - Pressing and releasing the S button will increase the Second Digit from 0 to 9 in increments of 1.
 - Depressing the S button will scroll through the Set Points at a rate of 4 per second.
 - Pressing and releasing the A button (< 2 seconds) will accept the Second Digit of the Code and/or advance to the Third Digit which will be flashing.

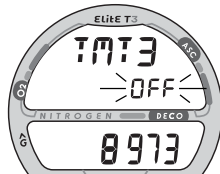

If TMT 2-3 USE is set for
SELF (Gas Switching)

- OR -



If TMT 2-3 USE is set for
Buddy Pressure Check

Fig. 45 - Set TMT 3 or BUD 2

- Pressing and releasing the S button repeatedly (< 2 seconds each) will increase the Third Digit from 0 to 9 in increments of 1.
- Depressing the S button will scroll through the Set Points at a rate of 4 per second.
- Pressing and releasing the A button (< 2 seconds) will accept the Third Digit of the Code and/or advance to the Fourth Digit which will be flashing.
- Pressing and releasing the S button repeatedly (< 2 seconds each) will increase the Fourth Digit from 0 to 9 in increments of 1.
- Depressing the S button will scroll through the Set Points at a rate of 4 per second.
- Pressing and releasing the A button (< 2 seconds) will accept the Fourth Digit of the Code and/or advance to the Fifth Digit which will be flashing.
- Pressing and releasing the S button repeatedly (< 2 seconds each) will increase the Fifth Digit from 0 to 9 in increments of 1.
- Depressing the S button will scroll through the Set Points at a rate of 4 per second.
- Pressing and releasing the A button will accept the Fifth Digit of the Code and/or advance to the Sixth Digit which will be flashing.
- Pressing and releasing the S button repeatedly (< 2 seconds each) will increase the Sixth Digit from 0 to 9 in increments of 1.
- Depressing the S button will scroll through the Set Points at a rate of 4 per second.
- Pressing and releasing the A button (< 2 seconds) will accept the TMT 3 (or BUD 2) Link Code and/or advance to the SET U screen.

SET T GROUP (TIME/DATE)

Set T Sequence:

SET T > Hour Format > Hour > Minute > Year > Month > Day

- > The SET T Group can also be set/changed using the PC Settings Upload program.
- > SET T Settings remain at the values set until changed.
- > FREE Mode utilizes these settings.
- > Day of the Week is set automatically when the Date is set.
- Depressing the A and S buttons simultaneously for 8 seconds while the NORM or GAUG SURF MAIN screen is displayed, will access SET T identified by the graphic SETT (Fig. 46).
- Depressing the M button at any time for 2 seconds and if no button is pressed during a period of 2 minutes, the unit will revert to the NORM or GAUG SURF MAIN screen.
- Pressing and releasing the A button momentarily (< 2 seconds) while SET T is displayed will advance to SET HOUR FORMAT with the Set Point flashing.

The YEAR will not be displayed in any Mode other than SET DATE. The DATE will reset to 1.1 2006 when the Battery is replaced.



Fig. 46 - Set T

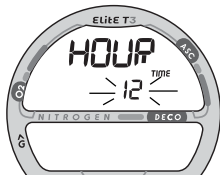

Fig. 47 - Set Hour Format

SET HOUR FORMAT information includes (Fig. 47):

- > Graphic HOUR
 - > Set Point 12 (or 24), flashing.
 - > Symbol TIME.
- Pressing and releasing the S button momentarily (< 2 seconds) will toggle between 12 and 24.
 - Pressing the A button momentarily (< 2 seconds) will save the Hour Format Set Point and access the SET TIME screen with the HOUR Set Point flashing (Fig. 48).
 - HINT - Pressing the A button repeatedly (< 2 seconds each) will step through the Time/Date Settings, bypassing those that don't require setting.

SET TIME (Hour and Minute)

The graphic Am or Pm will be displayed when 12 Hour Format has been selected.



Fig. 48 - Set Time

- Depressing the S button while the HOUR Set Point is flashing will scroll through the Set Points in 1 Hour increments at a rate of 4 per second from 12: Am to 11: Pm (or 0: to 23: if set for 24 Hour Format).
- Pressing and releasing the A button momentarily (< 2 seconds) will save the Hour Set Point and/or advance to SET MINUTE with the MINUTE Set Point flashing.

- Depressing the S button while the MINUTE Set Point is flashing will scroll through the Set Points in 1 minute increments at a rate of 4 per second from :00 to :59.
- Pressing and releasing the A button momentarily (< 2 seconds) will save the Minute Set Point and/or advance to the SET DATE screen.

SET DATE (Year, Month, and Day)

Displayed will be the graphic YEAR, Month and Day (or Day and Month if set for metric) with the YEAR Set Point flashing (Fig. 49).

- Depressing the S button will scroll through the YEAR Set Points in 1 year increments at a rate of 4 per second from 2006 to 2049 (with leap year corrections).
- Pressing and releasing the A button momentarily (< 2 sec) will save the Year Set Point and/or advance to SET MONTH with the Set Point flashing and the graphic MNTH replacing the graphic YEAR.
- Depressing the S button will scroll through the MONTH Set Points in 1 month increments at a rate of 4 per second from 1 to 12.
- Pressing and releasing the A button momentarily (< 2 seconds) will save the Month Set Point and/or advance to SET DAY with the Set Point flashing and the graphic DAY (replacing the graphic MNTH).
- Depressing the S button will scroll through the DAY Set Points in one day (01) increments at a rate of 4 per second from 1 to 31.
- Pressing and releasing the A button momentarily (< 2 seconds) will save the Set Point and/or advance to the SET screen.

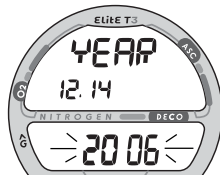

Fig. 49 - Set Date

SERIAL NUMBER (Elite T3)

- Depressing the A and S buttons simultaneously for 10 seconds while viewing the NORM or GAUG SURF MAIN screen will access the VT3's SERIAL NUMBER screen displaying (Fig. 50):
 - > Graphic SN
 - > Factory programmed Serial Number of the Elite T3.
 - > Firmware revision number (e.g., graphic r1A).
- Depressing the A and S buttons simultaneously for 2 seconds will revert to the SURF MAIN screen.
- Depressing the M button for 2 seconds will revert to the SURF MAIN screen.
- If no button is pressed during a period of 2 minutes, the unit will revert to the SURF MAIN screen.

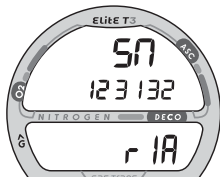

Fig. 50 - SERIAL NUMBER
(of the Elite T3)

△ NOTE: The Serial Number and Firmware Revision will be requested in the event that you contact AERIS regarding your Elite T3. Enter them in the Records section provided in the back of this Manual.

NORM SURF ALT, information includes (Fig. 51):

- > Day of the Week graphic (SAT, SUN, MON, TUE, WED, THU, FRI).
 - > Temperature with degree icon and graphic F (or C)
 - > Time of Day (hour:minute).
-
- Pressing and releasing the A button momentarily (< 2 seconds) will access the NORM PLAN Lead-in screen.
 - Pressing the S button will activate the Backlight.
 - The display will revert to the NORM SURF MAIN screen if the M button is pressed for 2 seconds or after 2 minutes with no button action.

NORM PLAN MODE

AERIS strongly recommends that you review the Pre Dive Planning Sequence (PDPS) prior to every NORM dive to help you Plan your dive as required to avoid exceeding no decompression or oxygen exposure limits. This is especially important for repetitive dives when the PDPS indicates adjusted dive times that are available for the next dive, based on residual nitrogen or oxygen accumulation (whichever is in control) following the last dive and surface interval.

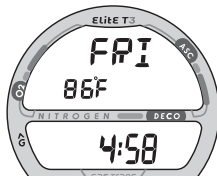

Fig. 51 - NORM SURF ALT

DEPTH FT (M)	NDL HR:MIN
30 (9)	4:20 (4:43)
40 (12)	2:17 (2:24)
50 (15)	1:21 (1:25)
60 (18)	:57 (:59)
70 (21)	:40 (:41)
80 (24)	:30 (:32)
90 (27)	:24 (:25)
100 (30)	:19 (:20)
110 (33)	:16 (:17)
120 (36)	:13 (:14)
130 (39)	:11 (:11)
140 (42)	:09 (:09)
150 (45)	:08 (:08)
160 (48)	:07 (:07)
170 (51)	:07 (:06)
180 (54)	:06 (:06)
190 (57)	:05 (:05)

NDLs, AIR Dive at Sea Level (no dive made yet)

Refer to the charts on pages 150 and 151 for complete listings of No Decompression Limits for Sea Level and Altitudes up to 14,000 feet (4,270 meters).

△ NOTE: No Decompression Dive Times in NORM PLAN MODE are based on the FO2 setting for GAS 1. The FO2 settings for GAS2 and GAS3 are not utilized for Plan calculations.

- Pressing and releasing the A button momentarily (< 2 seconds) 1 time while the NORM SURF MAIN screen is displayed will access the PLAN MODE Lead-in screen (NORM SURF > PLAN Lead-in).
- While in the PLAN MODE, pressing and releasing the S button repeatedly (< 2 seconds each time) will increase the Planned Depth in increments of 10 FT (3 M), displaying the information one screen at a time.

Information provided includes Depths and allowable No Decompression Dive Times. The screens will sequence through Depths from 30 to 190 FT (9 to 57 M), or the Maximum Depth that will allow theoretical No Decompression Dive Time of at least 1 minute based upon the previous dive profiles in a series of repetitive dives and taking into account descent and ascent rates of 60 FPM (18 MPM).

△ NOTE: When the Conservative Factor is set ON, No Decompression Dive times (NDLs) are reduced to the values of the next 3000 foot (915 meter) higher Altitude.

If FO2 for GAS1 is set for a numerical value (21 to 50%), the NITROX graphic and Maximum Operating Depth defined by the PO2 ALARM Set Point will be displayed.

If the limiting time factor is Oxygen controlled, the symbols TIME and O2 will be displayed. If the limiting time factor is Nitrogen controlled, the symbols TIME and NDC will be displayed.

- Prior to a first dive of a series, pressing and releasing the A button momentarily (< 2 seconds) will advance to LOG MODE.
- After a dive is made, it will advance to FLY MODE.
- Depressing the M button for 2 seconds, or if no button is pressed during a 2 minute period, operation will revert to the NORM SURF MAIN screen.

PLAN MODE LEAD-IN information includes (Fig. 52A/B):

- > Graphic PLAN.
 - > PO2 Alarm Set Point and graphic PO2, if set for Nitrox.
 - > FO2 icon and FO2 Set Point for GAS 1.
 - > Tank 1 icon representing GAS 1.
 - > Symbol NITROX, if set for Nitrox.
- Press and release the S button momentarily (< 2 seconds) to access the first screen (30 FT/9 M) of the Pre Dive Planning Sequence (PDPS).



Fig. 52A - PLAN LEAD-IN
(FO2 set for AIR)

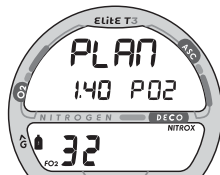

Fig. 52B - PLAN LEAD-IN
(FO2 set for 32%)

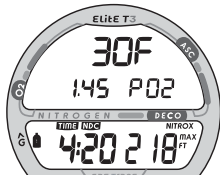

Fig. 53A - PDPS
(Nitrogen controlled)

PDPS information includes (Fig. 53A/B):

- > Plan Depth values and symbol F (feet) or M (meters).
- > PO2 Alarm Set Point and graphic PO2, if set for Nitrox.
- > Symbols TIME and NDC (or O2 if in control).
- > Dive Time (HR:MIN) allowed for the FO2 set for GAS 1.
- > Tank 1 icon representing GAS 1.
- > Symbol NITROX, if set for a Nitrox dive.
- > Maximum Depth allowed and symbols MAX and FT (or M).

- Press and release the S button momentarily and repeatedly (< 2 seconds each time) to increase the Planned Depth in increments of 10 FT (3 M), displaying the information one screen at a time.
- Depressing and holding the M button for 2 seconds to revert to the NORM SURF MAIN screen.

FLY MODE

Time to Fly is a counter that begins counting down 10 minutes after surfacing from a dive from 23:50 to 0:00 (hr:min).

Two hours after a NORM or FREE dive, the FLY screen will alternate with the SAT screen until the Elite T3 shuts Off 24 hours after the last dive. When operating in FREE Mode, the FLY screen can be viewed by first accessing the NORM SURF MAIN screen.

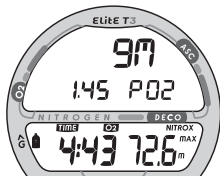

Fig. 53B - PDPS
(O2 controlled)

During the first 2 hours after a dive -

- pressing and releasing the A button 3 times momentarily (< 2 seconds each time) while the NORM SURF MAIN screen is displayed will access FLY MODE (NORM SURF MAIN > ALT > PLAN > FLY, or -
- pressing and releasing the A button 2 times momentarily (< 2 seconds each) while the GAUG SURF MAIN screen is displayed will access FLY MODE (GAUG SURF MAIN > ALT > FLY).

TIME TO FLY information includes (Fig. 54):

- > Graphic FLY and symbol TIME.
 - > Countdown Time (hr:min).
 - > Battery icon if a Elite T3 Low Battery Warning Condition exists, flashing if Too Low
-
- Pressing and releasing the A button momentarily (< 2 seconds) will advance to SAT MODE.
 - Depressing the M button for 2 seconds will revert to the NORM or GAUG SURF MAIN screen.
 - If no button is pressed during a 2 minute period, operation will revert to the NORM or GAUG SURF MAIN screen.
 - Pressing the S button will activate the Backlight.

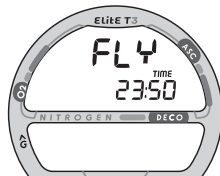

Fig. 54 - Time to Fly

SAT MODE

The Time to Desaturate counter provides calculated time for Tissue Desaturation at sea level taking into consideration the Conservation Factor setting. It begins counting down 10 minutes after surfacing from a dive, counting down from 23:50 max to 0:00 (hr:min).

When the Countdown reaches 0:00, which will generally occur prior to the FLY count-down reaching 0:00, the SAT screen continues to alternate with FLY displaying 0:00 until the FLY counter shuts the Elite T3 Off 24 hours after a last dive.

- > The SAT screen is not displayed after a Violation Dive.
- > Desaturation requiring Times greater than 24 hours will display 23: -- .
- > In the event that Time to Desaturate still remains at the end of 24 hours, the added time will be zeroed.

During the first 2 hours after a dive -

- pressing and releasing the A button 4 times momentarily (< 2 seconds each time) while the NORM SURF MAIN screen is displayed will access SAT MODE (NORM SURF MAIN > ALT > PLAN > FLY > SAT, or -
- the SAT screen is not accessible from GAUG SURF MAIN.

Two hours after a NORM or FREE dive, the SAT screen will alternate with the FLY screen until the Elite T3 shuts Off 24 hours after the last dive. When operating in FREE Mode, the SAT screen can be viewed by first accessing the NORM SURF MAIN screen.

TIME TO DESATURATE information includes (Fig. 55):

- > Graphic SAT and symbol TIME.
 - > Countdown Time (hr:min).
 - > Battery icon (if an Elite T3 Low Battery Warning Condition exists), flashing if Too Low
-
- Pressing and releasing the A button momentarily (< 2 seconds) will advance to LOG MODE.
 - Depressing the M button for 2 seconds will revert to the NORM or GAUG SURF MAIN screen.
 - If no button is pressed during a 2 minute period, the unit will revert to the NORM or GAUG SURF MAIN screen.
 - Pressing the S button will activate the Backlight.

NORM/GAUG LOG MODE

LOG MODE displays information from the latest 24 NORM/GAUG dives sequentially in reverse order (the most recent first).

LOG information is retained until deleted by another dive.

- > After exceeding 24 dives, the most recent Dive completed will be added to the LOG and the oldest deleted.

Battery removal will not affect the LOG data stored for viewing.

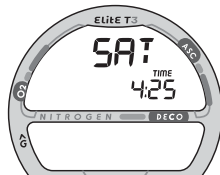

Fig. 55 - Time to Desat

Dives will be numbered 1 to 24 starting at #1 each time a new series of dives begins. After it shuts Off 24 hours after a dive, the first dive of the next new series will be #1.

Accessing LOG Mode:

- During the first 10 minutes after a dive, pressing and releasing the A button momentarily (< 2 seconds) 1 time while the NORM or GAUG SURF MAIN screen is displayed will access LOG MODE. (NORM or GAUG SURF MAIN > LOG)
- 10 minutes after a Non Violation Dive, pressing and releasing the A button 5 times (< 2 seconds each time) while the NORM SURF MAIN screen is displayed will access the LOG MODE (NORM SURF MAIN > PLAN > FLY > SAT > LOG), or -
> pressing and releasing the A button 2 times (< 2 seconds each time) while the GAUG SURF MAIN screen is displayed will access the LOG MODE (GAUG SURF MAIN > FLY > LOG).
- 10 minutes after a Violation Dive, pressing and releasing the A button 23 times (< 2 seconds each time) while the NORM or GAUG SURF MAIN screen is displayed will access the LOG MODE (NORM or GAUG SURF MAIN > FLY LOG). PLAN and SAT screens will not be available after a Violation Dive.

Upon accessing LOG MODE, the most recent NORM or GAUG dive's LOG PREVIEW screen will be displayed.

- Depressing the S button for 2 seconds will display the previous dive's PREVIEW screen. Subsequent presses of S will step through other previous dives' PREVIEW screens.

- Pressing and releasing the S button momentarily (< 2 seconds) while viewing a PREVIEW screen will display that dive's LOG DATA 1 screen (Nitrogen Data).
- If that was a Nitrox dive, pressing and releasing the S button again will display that dive's LOG DATA 2 screen (Oxygen Data). If in GAUGE MODE (Violated or User Selected), this screen will not be displayed.
- LOG screens remain on display until further button action occurs.
- Once the S button is pressed, pressing and releasing the A button momentarily (< 2 seconds) button will revert to NORM or GAUG SURF MAIN screen.
- Depressing and holding the M button for 2 seconds or if no button is pressed during a 2 minute period operation will revert to the NORM or GAUG SURF MAIN screen.
- Pressing the S button will activate the Backlight.

LOG PREVIEW screen information includes (Fig. 56):

- > Graphic LOG.
- > Date (month.day, or day.month if set for metric).
- > Symbol DIVE and dive number (1 to 24) for that series.
- > Time of Day the dive began (hr:min) with graphic Am/Pm if set for 12 Hour Format.
- > Symbol NITROX if a Nitrox dive, none if a NORM AIR, or GAUG dive.
- Pressing and releasing the S button momentarily (< 2 seconds) button will advance to the LOG DATA 1 screen.
- Pressing and holding the S button will scroll through the previous Log Preview screens.

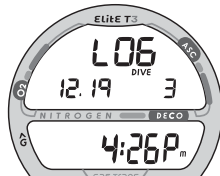

Fig. 56 - LOG PREVIEW

LOG DATA 1 information includes (Fig. 57):

- > Alpha graphic NO-D, DECO, GAUG, or VIOL.
- > NIBG with the maximum accumulation segment flashing, others fixed up to end-of-dive accumulation. All segments flashing for delayed and full violation.
- > VAR1 - showing the maximum ascent rate maintained for 4 consecutive seconds during the dive.
- > Temperature (minimum recorded that dive) and graphic F (or C).
- > Symbols DIVE and TIME and Elapsed Dive Time (hr:min).
- > Symbols TIME and SURFACE.
- > Pre-dive Surface Interval (hr:min), 10 - through 23 - for times greater than 9:59 (hr:min), blank for Dive 1 of a series.
- > Maximum Depth and symbols MAX and FT (or M).
- > Symbol NITROX, if a NORM Nitrox dive, none if a NORM AIR or GAUG dive.

- Pressing and releasing the S button momentarily (< 2 seconds) button will advance to the LOG DATA 2 screen.
- Depressing the M button for 2 seconds or if no button is pressed during a 2 minute period operation will revert to the NORM or GAUG SURF MAIN screen.
- Pressing the S button will activate the Backlight.

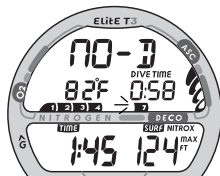

Fig. 57 - LOG DATA 1

LOG DATA 2 (if a Nitrox dive) information includes (Fig. 58):

- > Graphic O₂.
 - > O₂ bar graph segments representing Oxygen accumulated at the end of the dive.
 - > Value of Max PO₂ achieved (ATA) and graphic PO₂.
 - > GAS 1 FO₂ Set Point for that dive and symbol FO₂.
 - > Tank 1 icon representing GAS 1.
 - > Symbol NITROX.
- Pressing and releasing the S button momentarily (< 2 seconds) button will advance to the previous dive's LOG PREVIEW screen.
 - Depressing the M button for 2 seconds or if no button is pressed during a 2 minute period operation will revert to the NORM or GAUG SURF MAIN screen.
 - Pressing the S button will activate the Backlight.

△ NOTE: FREE Dives are not recorded in the Elite T3's LOG. The data is stored in Memory for subsequent Download to the AERIS Computer Interface program.

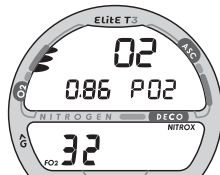

Fig. 58 - LOG DATA 2

NORM/GAUG HISTORY MODE

HISTORY Mode displays accumulative NORM and GAUG dive information.

Battery removal will not affect the HISTORY data stored for viewing.

10 minutes after a dive -

- pressing and releasing the A button 6 times momentarily (< 2 seconds each time) while the NORM SURF MAIN screen is displayed will access HISTORY (NORM SURF MAIN > ALT > PLAN > FLY > SAT > LOG > HISTORY), or -
- pressing and releasing the A button 4 times momentarily (< 2 seconds each) while the GAUG SURF MAIN screen is displayed will access HISTORY (GAUG SURF MAIN > ALT > FLY > LOG > HISTORY).
- Pressing and releasing the A button momentarily (< 2 seconds) will advance to the NORM or GAUG SURF MAIN screen.
- Depressing the M button for 2 seconds or if no button is pressed during a 2 minute period operation will revert to the NORM or GAUG SURF MAIN screen.
- Pressing the S button will activate the Backlight.

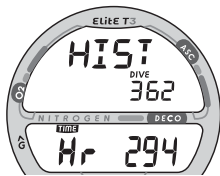

Fig. 59 - HISTORY 1

HISTORY 1 screen information includes (Fig. 59):

- > Graphic HIST.
- > Symbol DIVE and total number of All NORM and GAUG dives recorded up to 9999.
- > Symbol TIME and graphic Hr with the Total Hours of Elapsed Dive Time up to 9,999.
- Pressing and releasing the S button momentarily (< 2 seconds) button will advance to the HISTORY 2 screen.

HISTORY 2 screen information includes (Fig. 60):

- > Graphic SEA (or EL 2 through EL 13), highest Altitude at which a NORM or GAUG dive was conducted.
 - > Temperature, lowest recorded of all NORM and GAUG dives.
 - > Maximum Depth achieved during all NORM and GAUG dives with symbols FT (or M) and MAX.
- Pressing and releasing the S button momentarily (< 2 seconds) button will advance to the NORM or GAUG SURF MAIN screen.
 - Depressing the M button for 2 seconds or if no button is pressed during a 2 minute period operation will revert to the NORM or GAUG SURF MAIN screen.
 - Pressing the S button will activate the Backlight.

△ NOTE: FREE Dives are not recorded in the Elite T3's HISTORY. The data is stored in Memory for subsequent Download to the AERIS Computer Interface program.

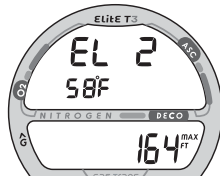

Fig. 60 - HISTORY 2

OVERVIEW OF DISPLAYED SYMBOLS AND ICONS

SYMBOLS

BAR (or) PSI
STOP TIME (or) DIVE TIME

AIR TIME (or) -
TIME NDC (or) -
TIME O₂ (or) -
TIME TAT (or) -
TIME SURF

NITROX
FO₂
FT (or) M
MAX

MEANING

Selected Tank's Pressure Units
Ceiling Stop Time or Elapsed Dive Time (hr:min if NORM or GAUG; min:sec if FREE) or Dive #
Air Time Remaining (hr:min)
No Decompression Dive Time Remaining (hr:min)
O₂ Dive Time Remaining (hr:min)
Ascent Time plus Deco Stop Times (hr:min)
Elapsed Surface Interval Time (hr:min if NORM or GAUG, or FREE > 59:59; min:sec if FREE up to 59:59)
FO₂ for any GAS is set at a numerical value (=>21%)
FO₂ Set Point is being displayed
Depth Units (Feet or Meters)
Maximum (Depth or PO₂)

ICONS

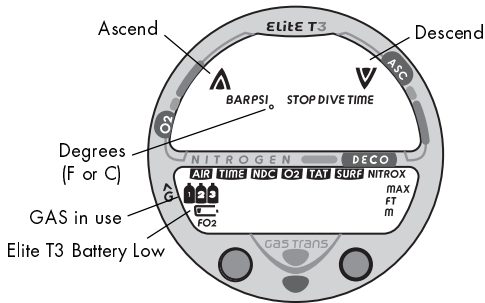



WARNING: Prior to diving with the Elite T3, you must also read and understand the AERIS Dive Computer Safety and Reference Manual, Doc. No. 12-7203, which provides Important Warnings and Safety Recommendations as well as general product information.

OVERVIEW OF DIVE MODE INFORMATION

**Poor
Reception
Distance
(greater than 6 feet/2 meters)**

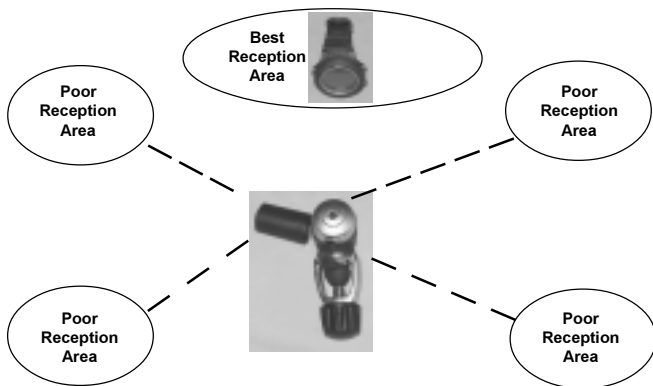

Transmitter Signal Reception Guide

POSITIONING OF THE Elite T3

The Transmitters (TMTs) emit low frequency signals that radiate outward in semicircular patterns that are parallel to the length dimension of the TMT. A coiled antenna inside the Elite T3 receives the signals when it is positioned within a zone parallel to or at a 45 degree angle to the TMT as illustrated on page 76.

The Elite T3 cannot effectively receive a signal when it is held out to the sides of the TMT or held at distances greater than 6 feet (2 meters) in front of the TMT. Best reception is achieved when the Elite T3 is within 3 feet (1 meter) of the TMT.

When installed into the high pressure ports of the Regulator First Stages, the TMTs must be positioned so that they face horizontally outward from the Tank Valves.

Link Interruption Underwater

During a dive, you may at times move the Elite T3 out of the signal pattern of the TMT, resulting in a temporary interruption of the Link signal.

An interruption lasting greater than 15 seconds will cause the Tank Pressure value to flash, the Audible Alarm to sound, and message TMTx > LINK > LOST to scroll (Fig. 61). The Link will be restored within 4 seconds after the Elite T3 is moved back into its correct position.

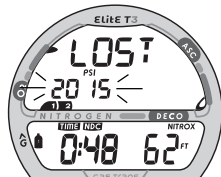
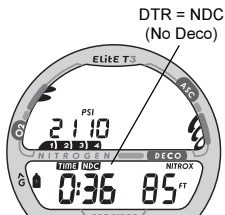
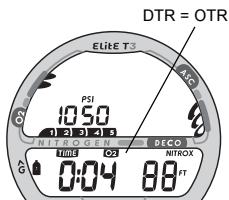

Fig. 61 - Link Interruption Underwater



An interruption of the TMT Link may also occur while the Elite T3 is in an area within 3 to 4 feet (1 meter) of a running Dive Propulsion Vehicle. The Link will be restored within 4 seconds after the Vehicle is shut off or the Elite T3 is moved out of that area. When using a Strobe, a temporary interruption may occur shortly after the Strobe flashes. The Link will be restored within 4 seconds.

DIVE TIME REMAINING (DTR)



One of the most important pieces of information on AERIS dive computers is the Dive Time Remaining numeric display. The Elite T3 constantly monitors No Decompression status, Oxygen Accumulation, and Breathing Gas Consumption Rate.

The Dive Time Remaining display (Fig. 62) will indicate the No Deco, O₂, or Air Time, whichever Time is the least amount available. The specific Time being displayed is identified by the symbols TIME and NDC (or O₂ or AIR).

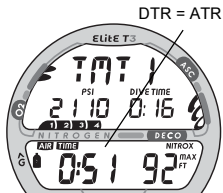

In the event that Air Time Remaining (ATR) becomes less than NDC and O₂ Time, after 1 minute the Audible Alarm will sound, the LED will flash, and the Pressure value will flash.

Fig. 62 - Dive Time Remaining

No Decompression Dive Time Remaining (NDC)

No Decompression Dive Time Remaining is the maximum amount of time that you can stay at your present Depth before entering a Decompression situation. It is calculated based on the amount of Nitrogen absorbed by hypothetical tissue compartments. The rates each of these compartments absorb and release Nitrogen is mathematically modeled and compared against a maximum allowable Nitrogen level. Whichever one is closest to this maximum level is the controlling compartment for that Depth. Its resulting value will be displayed numerically along with the symbols TIME and NDC (Fig. 63a) and graphically as the Nitrogen Loading Bar Graph (Fig. 63b).

As you ascend from Depth following a dive that has approached the No Decompression Limit, the NIBG segments will recede as control shifts to slower compartments. This is a feature of the Decompression Model that is the basis for Multilevel Diving, one of the most important advantages that AERIS dive computers offer.

The Elite T3's algorithm is based upon Haldane's theory using maximum allowable nitrogen levels developed by Merrill Spencer. Repetitive diving control is based upon experiments designed and conducted by Dr. Ray Rogers and Dr. Michael Powell in 1987. Diving Science and Technology® (DSAT), a corporate affiliate of PADI®, commissioned these experiments.

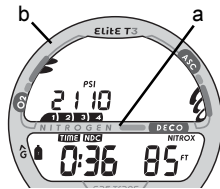

Fig. 63 - DTR is NDC

Oxygen Accumulation Time Remaining (OTR)

When the Elite T3 is set for Nitrox operation, Oxygen Accumulation (saturation or exposure) during a dive, or 24 hour period, appears graphically as the O₂ Bar Graph (O₂BG) (Fig. 64a). As time remaining before reaching the Oxygen Exposure Limit decreases, segments are added to the O₂BG.

When the amount of time remaining before reaching the Oxygen Limit becomes less than the No Decompression Dive Time Remaining, calculations for that Depth will be controlled by Oxygen. Oxygen Time Remaining (OTR) will then appear as the Dive Time Remaining (DTR) display (Fig. 64b) as signified by the symbols TIME and O₂. As Oxygen Accumulation continues to increase, segments will add to the O₂BG.

Air Time Remaining (ATR)

The Elite T3 calculates Air Time Remaining (ATR) using a patented algorithm that is based on a diver's individual Air Consumption Rate and Current Depth.

- > Tank Pressure is measured once each second and an average rate of Consumption is calculated over a 90 second period.
- > This Rate of Consumption is then used in conjunction with a knowledge of the Depth dependence to predict the Air required for the diver to make a safe controlled Ascent including any required Decompression Stops.

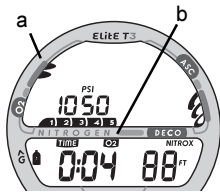

Fig. 64 - O₂ Time Remaining

Air Consumption and Depth are continuously monitored and Air Time Remaining reflects any change in circumstances. For example, when a buddy starts breathing from your Octopus or you suddenly find yourself swimming against a strong current and begin breathing more rapidly, the Elite T3 will recognize the change and adjust the ATR accordingly.

ATR is the time you can remain at the present Depth and still safely surface with the Tank Pressure Reserve that you selected during setup (End Pressure Alarm Setting).

ATR, identified by the symbols AIR and TIME (Fig. 65a), can be viewed when an Alternate Display is accessed during dive modes. In the event that ATR becomes less than No Deco and O2 Time, it will be displayed on the Main Display as Dive Time Remaining until it becomes greater than one or the other.

Air Time Remaining (ATR) Alarm

When ATR decreases to 5 minutes (0:05), the Audible Alarm will sound and the LED will flash.

If ATR decreases to 0:00, the Audible will sound and the LED will flash again. The message LOW > AIR > TIME will scroll at the top of the screen (Fig. 66) until ATR becomes greater than 5 minutes (0:05).

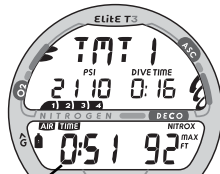

a
Fig. 65 - NORM DIVE ALT 2

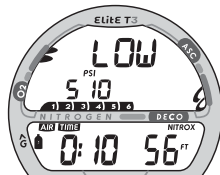

Fig. 66 - Low Air Time

You should immediately initiate a controlled Ascent while monitoring your Tank Pressure. However, there is no reason to panic, the Elite T3 has allowed for the Air necessary for a safe Ascent including the No Deco Safety Stop, if set On, and any Decompression Stops required.

Example:

- You set the End Pressure Alarm for 300 PSI (20 BAR)
- You are at a Depth of 60 FT (20 M)
- Air Time Remaining decreases to 0:00
- You Ascend at a maximum rate of 30 FPM (10 MPM)
- You surface with 300 PSI (20 BAR) pressure still in your Tank

ASCENT RATE ALARM

Alarms associated with Ascent Rate are based upon 2 sets of speeds which change at a reference depth of 60 FT (18 M).

⚠ WARNING: At depths greater than 60 FT (18 M), Ascent Rates should not exceed 60 FPM (18 MPM). At depths of 60 FT (18 M) and shallower, Rates should not exceed 30 FPM (9 MPM).

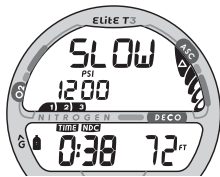

Fig. 67 - Ascent Rate Alarm

The Audible will sound, the red LED will flash, and the message SLOW > SLOW will scroll on/off at the top of the screen (Fig. 67). The Audible and LED will stop when acknowledged with the A button or when the Ascent is slowed. The message will continue to scroll until Ascent is slowed.

CONTROL OF DISPLAYS

During Dive Modes, there is a Main (Default) Display of important information relevant to the specific mode that the Elite T3 is operating in (No Deco, Deco, GAUG, FREE, etc.).

Alternate (ALT) Displays can be accessed by pressing and releasing the A button to view additional information. They will automatically revert to the Main Display after 3 seconds.

- MAIN > ALT 1 (Temp/Time) > ALT 2 (EDT/ATR) > ALT 3 (O2 Data, if set for Nitrox)

Alarms can be acknowledged/silenced by pressing the A button for 2 seconds.

The S button is used to activate the SmartGlo Backlight.

- The display will be illuminated as long as the button is depressed, plus the Backlight Duration time that has been set (0, 5, or 10 seconds) for a maximum of 20 seconds
- The Backlight will not activate during a Low Battery condition.

When TMT 2-3 USE is set for SELF, the M button is used for viewing Gas Switch Preview screens (FO2) and Switching Gas. When TMT2-3 USE is set for BUD, the M button is used for viewing Tank Pressure of 1 or 2 Buddies whose TMTs have been coded as the Elite T3's BUD 1 (TMT 2) and BUD 2 (TMT 3) settings.

-
- Left/Front - Mode/Mix (M) button
 - Right/Front - Advance (A) button
 - Right/Side - Select (S) button

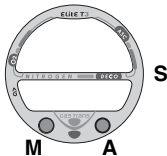

WET CONTACTS

The Wet Contact Dive Mode Activation feature is active any time WET ACTIVATION is set ON.

The Elite T3 is configured with contacts that will automatically activate Dive Mode when the space between the contacts is bridged by a conductive material (immersed in water) and it senses a Depth of 5 FT (1.5 M) for 5 seconds.

The contacts are the pins of the PC Interface Data Port and the stems of the Push Buttons.

As long as the contacts are bridged on the Surface, the graphic WET will alternate with the graphics NORM and SEA (or EL2 to EL13) on the NORM SURF MAIN screen (Fig. 68). Also on the GAUG and FREE SURF MAINS.

Upon removing the bridge between the contacts (drying the Elite T3), the graphic WET will no longer be displayed.

The Elite T3 will continue checking for Depth, until a dive is made or it shuts Off after 2 hours after activation.

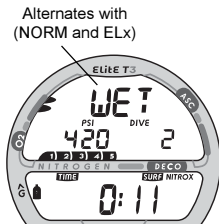

Fig. 68 - NORM SURF MAIN
(unit Wet)



WARNING: Prior to diving with the Elite T3, you must also read and understand the AERIS Dive Computer Safety and Reference Manual, Doc. No. 12-7203, which provides Important Warnings and Safety Recommendations as well as general product information.

NORM TYPE DIVE MODES

ABBREVIATIONS USED:

NIBG = NITROGEN LOAD-
ING BAR GRAPH

O2BG = OXYGEN ACCUMU-
LATION BAR GRAPH

VARI = VARIABLE ASCENT
RATE INDICATOR

DTR = DIVE TIME REMAIN-
ING

ATR = AIR TIME REMAINING

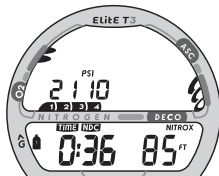

Fig. 69 - NORM DIVE NO
DECO MAIN

NORM NO DECOMPRESSION DIVE MODE

When the Wet Activation feature is set ON, the Elite T3 will enter the Dive Mode any time you descend to 5 FT (1.5 M).

When the Wet Activation feature is set OFF, the Elite T3 will not enter Dive Mode upon descent unless it is first Activated by push button and operating in one of the Dive Computer modes (menus) at that time, a mode such as Surface, Fly, Log, etc.

At any time during the dive -

- Press the S button to activate the SmartGlo Backlight.
- Depress the A button for 2 seconds to acknowledge and silence Alarms.

NORM DIVE NO DECO MAIN Display (Default),

information provided includes (Fig. 69) -

- > NIBG representing Nitrogen Loading
- > VARI while ascending
- > O2BG, if any during Nitrox dives
- > Tank Pressure with the PSI (or BAR) icon, if a TMT is active and linked, flashing after 1 minute of Lost Link
- > DTR (hr:min) with symbols TIME and NDC (or O2 or AIR)
- > Tank icon representing the GAS selected (1, 2, or 3)
- > Symbol NITROX, if FO2 set for Nitrox
- > Current Depth with symbol FT (or M)

- While the NORM DIVE MAIN screen is displayed, press/release the A button (< 2 sec) to view NORM DIVE ALT 1.
- While the NORM DIVE ALT 1 screen is displayed, press/release the A button (< 2 sec) to view NORM DIVE ALT 2.
- While the NORM DIVE ALT 2 screen is displayed, press/release the A button (< 2 sec) to view NORM DIVE ALT 3.

HINT:

ALT 1 is always Temperature, Time

ALT 2 displays EDT, Max Depth, TMT #, and ATR

ALT 3 displays selected GAS #, PO2, and FO2

- While the NORM DIVE MAIN screen is displayed, press the M button for 2 seconds to access the TMT 2-3 USE screen to enter the Gas Switch menu or Buddy Pressure Check.

NORM DIVE NO DECO ALT 1 Display.

information provided includes (Fig. 70) -

- > Day of the Week graphic (MON, TUE, etc.)
- > Temperature with degrees icon and graphic F (or C)
- > Time of Day (hr:min).

- Press/release the A button (< 2 sec) to view ALT 2.
- The display will revert to the MAIN Display after 3 seconds unless A is pressed to access the ALT 2 display.



Fig. 70 - NORM DIVE NO DECO ALT 1

During the time that an Alarm is sounding, Alternate and Gas Switch Preview displays cannot be accessed.

NORM DIVE NO DECO ALT 2 Display,

information provided includes (Fig. 71) -

- > NIBG representing Nitrogen Loading
 - > VARI while ascending
 - > O2BG, if any during Nitrox dives
 - > Graphic TMT1 (or 2 or 3), and
 - > Tank Pressure with the PSI (or BAR) icon, if a TMT is active and linked, flashing after 1 minute of Lost Link
 - > EDT (hr:min) with symbols DIVE and TIME
 - > ATR (hr:min) with symbols AIR and TIME
 - > Tank icon representing the GAS selected (1, 2, or 3)
 - > Symbol NITROX (if set for Nitrox)
 - > Max Depth with icons FT (or M) and MAX
-
- Press/release the A button (< 2 sec) to view ALT 3.
 - The display will revert to the MAIN Display after 3 seconds unless A is pressed to access the ALT 3 display.

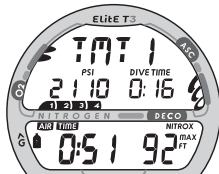

Fig. 71 - NORM DIVE
NO DECO ALT 2

△ NOTE: Access to the TMT 2-3 USE screen to enter the Gas Switch menu or Buddy Pressure Check can only be accomplished while viewing the NORM MAIN display.

NORM DIVE NO DECO ALT 3 Display (if set for Nitrox),

Information includes (Fig. 72) -

- > NIBG representing Nitrogen Loading
 - > VARI while ascending
 - > O2BG
 - > Graphic GAS1 (or 2 or 3) representing the GAS selected
 - > Level of PO2 (ATA) with graphic PO2
 - > FO2 Setting and symbol FO2
 - > Tank icon representing the GAS selected (1, 2, or 3)
 - > Symbol NITROX
 - > Current Depth and symbol FT (or M)
- The display will revert to the MAIN Display after 3 seconds.

△ NOTE: The Alternate Displays cannot be accessed during the time when an Alarm is sounding.

NORM DIVE NO DECO SAFETY STOP

Upon ascending to the Safety Stop Depth set on any NORM No Decompression dive in which Depth exceeded 30 FT (9 M), a short beep will be emitted and a Safety Stop at the Depth set will appear on the display with a countdown timer that begins at the Safety Stop Time set and counts down to 0:00 (min:sec).

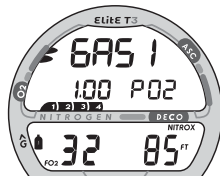

Fig. 72 - NORM DIVE
NO DECO ALT 3

The Safety Stop will be displayed until the countdown times out, or you descend below 30 FT (10 M), or you surface. There is no Penalty if you surface prior to completing the Safety Stop.

If the Safety Stop was set to OFF, the screen will not appear during the ascent.

NORM DIVE NO DECO SAFETY STOP MAIN Display,

Information includes (Fig. 73) -

- > Graphics SAFE, STOP, and xxF or xxM (value of the Stop Depth set) scrolling at the top
- > NIBG representing Nitrogen Loading
- > VARI if ascending
- > O2BG, if any during Nitrox dives
- > Tank Pressure with the PSI (or BAR) icon, if a TMT is active and linked
- > Symbols STOP and TIME and the Stop Time (min:sec) set
- > DTR (hr:min) with symbols TIME and NDC (or O2 or AIR)
- > Tank icon representing the GAS selected (1, 2, or 3)
- > Symbol NITROX (if set for Nitrox)
- > Current Depth with symbol FT (or M)

- Press/release the A button to view the NORM MAIN and ALT Displays previously described.

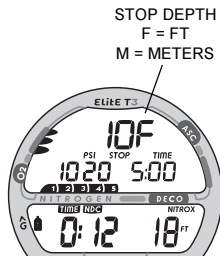

Fig. 73 - NORM DIVE NO DECO SAFETY STOP MAIN

DECOMPRESSION DIVE MODE

The Elite T3 is designed to help you by providing a representation of how close you are to entering Decompression.

Decompression Dive Mode activates when theoretical No Decompression time and depth limits are exceeded.

Upon Entry into Decompression Mode, the Audible Alarm will sound, the red LED Warning Light will flash, and the graphic message DECO > STOP will scroll each 3/4 second On and 1/4 second Off (Fig. 74), until acknowledged or for 10 seconds (unless set OFF).

- Depress the A button for 2 seconds to acknowledge/silence the Audible Alarm.
 - > The UP Arrow will flash if you are greater than 10 FT (3 M) deeper than the Required Stop Depth.
 - > Once you are within 10 FT (3 M) of, and below, the Required Stop Depth, the UP Arrow will be removed.
 - > Once silenced, the graphics DECO > STOP > xxF or xxM will scroll each 2 seconds On 2 seconds blank.

At any time during the dive -

- Depress the S button to activate the Backlight.
- Press/release the A button to access Alternate displays.

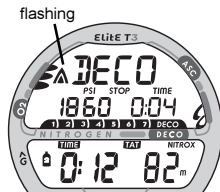

Fig. 74 - DECO ENTRY

To fulfill your decompression obligation, you should make a safe controlled Ascent to a depth slightly deeper than (Fig. 75a), or equal to, the Required Ceiling Stop Depth indicated (Fig. 75b) and decompress for the Stop Time indicated (Fig. 75c).

The amount of decompression Credit Time that you receive is dependent on Depth, with slightly less Credit given the deeper you are below the Stop Depth indicated.

You should stay slightly deeper than the Required Stop Depth indicated until the next shallower Stop Depth appears. Then, you can slowly ascend to, but not shallower than that indicated Ceiling Stop Depth.

DECO STOP MAIN Display (Default), information provided includes (Fig. 75) -

- > Graphics DECO, STOP, and xxF or xxM (the Stop Depth) scrolling at the top
- > NIBG representing Nitrogen Loading
- > O2BG, if any during Nitrox dives
- > Tank Pressure with the PSI (or BAR) icon, if a TMT is active and linked
- > Symbols STOP and TIME and Stop Time (hr:min) required
- > Symbols TIME and TAT and Total Ascent Time (hr:min) required
- > Tank icon representing the GAS selected (1, 2, or 3)
- > Symbol NITROX (if set for Nitrox)
- > Current Depth with symbol FT (or M)

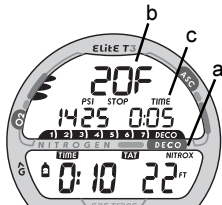

Fig. 75 - DECO STOP MAIN

- Press/release the A button (< 2 sec) to view DECO STOP ALT 1, then ALT 2 and ALT 3.

DECO MAIN > ALT 1 > ALT 2 > ALT 3

- Depress the M button for 2 seconds to access the Gas Switch or Buddy Pressure Check menu.

Total Ascent Time (TAT)

Total Ascent Time includes Stop Times required at all required decompression ceilings (Stops) and vertical Ascent Time to the surface calculated at 60 FPM (18 MPM) for depths deeper than 60 FT (18 M), and 30 FPM (9 MPM) for depths of 60 FT (18 M) and shallower.

DECO STOP ALT 1 Display, information provided includes Fig. 76] -

- > Day of the Week graphic (MON, TUE, etc.)
 - > Temperature with degrees icon and graphic F (or C)
 - > Time of Day (hr:min).
- Press/release the A button (< 2 sec) to view DECO STOP ALT 2.
 - The display will revert to the DECO STOP MAIN Display after 3 seconds unless A is pressed.

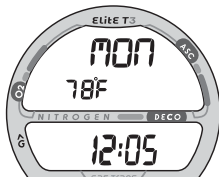

Fig. 76 - DECO STOP ALT 1

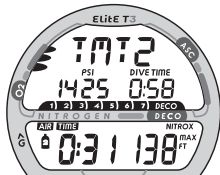

Fig. 77 - DECO STOP ALT 2

DECO STOP ALT 2 Display, information includes (Fig. 77) -

- > Graphic TMT1 (or 2 or 3) and Tank Pressure with the PSI (or BAR) icon, if a TMT is active and linked
- > NIBG, all segments
- > O2BG, if any during Nitrox dives
- > EDT (hr:min) with symbols DIVE and TIME
- > ATR (hr:min) with symbols AIR and TIME
- > Tank icon representing the GAS selected (1, 2, or 3)
- > Symbol NITROX (if set for Nitrox)
- > Max Depth with icons FT (or M) and MAX

- Press/release the A button to view DECO STOP ALT 3.
- The display will revert to the DECO STOP MAIN Display after 3 seconds unless the A button is pressed.

DECO STOP ALT 3 Display, information includes (Fig. 78) -

- > Graphic GAS1 (or GAS2 or GAS3)
- > NIBG, all segments
- > O2BG, if any during Nitrox dives
- > Level of PO2 (ATA) with graphic PO2
- > FO2 Setting and symbol FO2
- > Tank icon representing the GAS selected (1, 2, or 3)
- > Symbol NITROX
- > Current Depth and symbol FT (or M)

- The display will revert to the DECO MAIN after 3 seconds.



Fig. 78 - DECO STOP ALT 3

VIOLATION MODES

While in Violation Modes, the Alternate Displays previously described can be accessed using the A button, the Backlight can be activated using the S button, and Alarms can be acknowledged and silenced with the A button.

- Alternate Displays will be similar to the DECO screens and not repeated. They revert to the MAIN (Default) Display after 3 seconds unless A is pressed.

NORM CONDITIONAL VIOLATION

If you ascend shallower (Fig. 79a) than a Required Decompression Ceiling Stop Depth (Fig. 79b), the Audible Alarm will sound, and the red LED, Down Arrow, and Full NIBG will flash until you descend below the Required Stop Depth. The graphic message DOWN > DOWN will scroll at the top of the display until the Alarm is acknowledged/silenced, then the message DOWN > TO > xxF or xxM will scroll.

If you descend below the required Decompression Ceiling before 5 minutes have elapsed, the Elite T3 will continue to function in Decompression Dive Mode. In this case, no off gassing Credit will be given, and for each minute above the Ceiling $1\frac{1}{2}$ minutes of **Penalty Time** will be added to Required Stop Time.

- > The added Penalty (decompression) Time will have to be 'worked off' first, before obtaining off gassing Credit.
- > Once the Penalty Time is worked off, and off gassing Credit begins, required Deco Stop Depths and Time will decrease toward zero. The NIBG will recede into the No Deco Zone and the Elite T3 will revert to the No Deco Dive Mode.

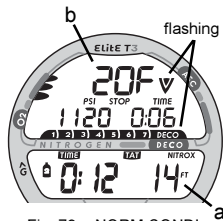

Fig. 79 - NORM CONDITIONAL VIOLATION MAIN

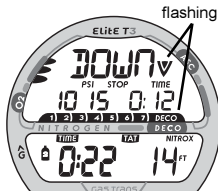

Fig. 80 - NORM DELAYED VIOLATION #1 MAIN

NOTE: Upon entry into the following 3 Delayed Violation Modes, the red LED flash and the Audible Alarm will sound, even if Set OFF. When these events occur, the Alarm cannot be acknowledged (silenced) by pressing the A button.

NORM DELAYED VIOLATION #1 (Fig. 80)

If you remain above the Required Ceiling Stop Depth for more than 5 minutes, the full NIBG and DOWN Arrow will flash until you descend below the Required Stop Depth. The graphic message DOWN > TO > xxF (or xxM) will continue to scroll.

> This is a continuation of a Conditional Violation.

NORM DELAYED VIOLATION #2 (Fig. 81)

The Elite T3 cannot calculate Decompression times for Stop Depths much greater than 60 FT (18 M) and offers no indication of how much time spent underwater would result in the need for a greater Stop Depth.

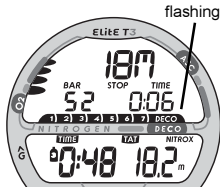

Fig. 81 - NORM DELAYED VIOLATION #2 MAIN

If the Decompression obligation requires a Ceiling Stop Depth between 60 FT (18 M) and 70 FT (21 M), the NIBG will flash and the graphic message DECO > STOP > 60F (18M) will scroll at the top of the display.

When Delayed Violation #2 occurs, you must make a controlled Ascent to just deeper than, and stay as close as possible to, 60 FT (18 M) without causing the NIBG to flash. When the Required Stop Depth indicates 50 FT/15 M, etc., you can ascend to those Stop Depths and continue decompressing.

NORM/GAUG DELAYED VIOLATION #3 (Fig. 82)

If you descend deeper than the Maximum Operating Depth of 330 FT (100 M), or 399 FT (120 M) when operating in GAUG Mode, the UP Arrow will flash, and the Current Depth and Max Depth (on ALT 2) displays will only indicate 3 dashes (- - -) signifying that you are Out of Range.

The graphic message TOO > DEEP will scroll at the top of the display until Ascent is made above 330 FT (100 M), or 399 FT (120 M) when operating in GAUG Mode.

Upon ascending above those Depths, the Current Depth display will be restored, however Max Depth (on ALT 2) will only display 3 dashes for the remainder of that dive. Also, the Log for that dive will display 3 dashes as the Max Depth achieved.

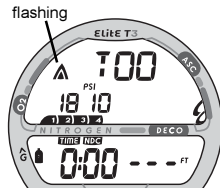

Fig. 82 - DELAYED VIOLATION #3 MAIN

IMMEDIATE VIOLATION AND VIOLA GAUGE MODE

If a Decompression Ceiling Stop Depth much greater than 60 FT (18 M) is required, an Immediate Violation Mode will be entered. This situation would be preceded by entering Delayed Violation Mode #2.

The Elite T3 would then operate in Violation Gauge Mode during the remainder of that dive and for 24 hours after surfacing. Violation Gauge Mode turns the Elite T3 into a digital instrument without any decompression or oxygen monitoring functions.

VIOLATION GAUGE DIVE MAIN DISPLAY (Default),

information provided includes (Fig. 83) -

- > Message UP > VIOL, scrolling
- > Full NIBG and O2BG, both flashing signifying Violation
- > VARI if ascending
- > Tank Pressure with the PSI (or BAR) icon, if a TMT is active and linked
- > Symbols TIME and NDC with 0:00 (hr:min) Time Remaining
- > Tank icon representing the GAS selected (1, 2, or 3)
- > Symbol NITROX (if set for Nitrox)
- > Current Depth with symbol FT (or M)

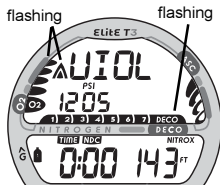

Fig. 83 - VIOLATION GAUGE
DIVE MAIN

The Elite T3 will also enter an Immediate Violation Mode (Violation Gauge Mode) 5 minutes after surfacing from a dive in which a Delayed Violation occurred.

Violation Gauge Mode on the Surface does not allow access to the SET F, PLAN, FLY, and SAT features/screens.

The countdown timer that appears when you try to access Time to Fly does not represent Time to Fly. It is only provided to inform you of the time remaining before normal operation can resume with full Elite T3 features and functions.

This condition is a Permanent Violation, and in the event that a dive is made during the 24 hour period, a full 24 hour surface interval must then be served before all functions are restored.

VIOLATION GAUGE SURF MAIN Display (Default),

information provided includes (Fig. 84) -

- > Full NIBG and O2BG, both flashing signifying Violation
- > Message VIOL > VIOL, scrolling for the first 10 minutes
- > Tank Pressure with the PSI (or BAR) icon, if a TMT is active and linked
- > Symbol DIVE and number of that dive
- > Symbols TIME and SURF with Surface Interval Time (hr:min)
- > Tank icon representing GAS1 (surface default)
- > Symbol NITROX (if set for Nitrox)

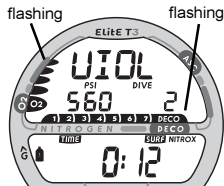

Fig. 84 - VIOLATION GAUGE SURF MAIN

! WARNING:

If a High PO2 condition occurs while in Deco Mode, the message HIGH > PO2 will replace the DECO message until PO2 < 1.60.



Fig. 85 - HIGH PO2 MAIN

NORM HIGH PO2

When partial pressure of oxygen (PO2) becomes equal to, or greater than, 0.2 ATA less than the PO2 Alarm Set Point (a SET A Group setting); the red LED warning light will flash, the Audible Alarm will sound, and the message HIGH > PO2 will scroll until the Alarm is acknowledged/silenced.

- The graphic PO2 and UP Arrow will appear solid on the MAIN Display (Fig. 85) as a warning until PO2 decreases.
- After the Alarm is silenced, the graphic message UP > HIGH > PO2 will scroll.

If PO2 continues to increase, the value displayed will increase in increments of .01 ATA to a maximum value of 5.00 ATA.

When PO2 reaches the PO2 Alarm Set Point, the red LED warning light will flash and the Audible Alarm will sound again.

- > The graphic PO2 and UP Arrow will flash as a warning until PO2 decreases below the Alarm Set Point.
- > The message UP > HIGH > PO2 will continue to scroll.
- > The value of PO2 can be viewed by accessing the ALT 2 Display by pressing/releasing the A button 2 times.
- > The unit will revert to the MAIN Display after 3 seconds.

HIGH OXYGEN ACCUMULATION

The O2 Bar Graph (O2BG) displays either oxygen accumulated during that nitrox dive, or during the repetitive nitrox dives you conduct during that 24 hour period, whichever of the two is greater at that time. The O2BG allows you to monitor how close you are coming to the limits of oxygen exposure.

If the theoretical amount of oxygen accumulated equals, or exceeds, the limit for a single exposure, or the exposure limit for a 24 hour period (300 OTU), Oxygen Dive Time Remaining becomes 0:00 (hr:min), the graphic O2 appears and the full O2 Bar Graph and UP Arrow will be displayed flashing (Fig. 86).

The red LED warning will flash, the Audible Alarm will sound, and the message HIGH > O2 will scroll at the top of the display. When the Alarm is acknowledged/silenced, the message UP > HIGH > O2 will scroll until the level of oxygen decreases below the limit.

- Press/release the A button to view the Alternate displays.
 - > The unit will revert to the MAIN Display after 3 seconds.

Upon surfacing during a High O2 Alarm condition, operation will lock into NORM Mode, blocking access to GAUG and FREE, until the O2BG recedes to 4 segments.

A chart listing the NOAA O2 limits is provided on page 151.

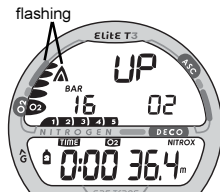

Fig. 86 - HIGH O2 MAIN

SUMMARY OF NORM/GAUG WARNING AND ALARM MESSAGES

MESSAGE

MEANING

DECO > STOP > xxF (M)	Entry into Decompression Mode.
DOWN > TO > xxF (M)	Above Required Decompression Stop Depth.
DECO > STOP > 60F (18M)	Deco Stop greater than 60 FT (18 M) required.
HIGH > PO2	High PO2 while in Deco Mode.
UP > HIGH > PO2	Exceeded PO2 alarm Set Point.
UP > HIGH > O2	High O2 alarm.
TOO > DEEP	Depth alarm.
UP > VIOL	Deco Stop greater than 70 FT (21 M) required.
SLOW > SLOW	Ascent Rate Too Fast alarm.
LOW > AIR > TIME	Air Time Remaining alarm (less than 5 minutes).
LOW > DIVE > TIME	Dive Time Remaining alarm (NDC, O2, or ATR).
TURN > GAS > ALRM	TMT1 Turn Pressure alarm.
END > GAS > ALRM	TMT End Pressure alarm (TMT in use).
TIME > TOO > LONG	Elapsed Dive Time alarm.
UP > HIGH > NI	NIBG alarm.
TMT1 > LINK > LOST	Active TMT Transmission Link Lost (also TMT2 and TMT3).
TMT1 > NotAvail	TMT not active (also TMT2 and TMT3).
DONT > SWCH	Don't Switch to the new Gas (exposure to excess PO2).



WARNING: Prior to diving with the Elite T3, you must also read and understand the AERIS Dive Computer Safety and Reference Manual, Doc. No. 12-7203, which provides Important Warnings and Safety Recommendations as well as general product information.

SWITCHING GAS MIXES AND BUDDY PRESSURE CHECK

SWITCHING GAS MIXES (NORM only)

During NORM Dives, the Elite T3 can be manually switched from GAS 1 to GAS 2 to GAS 3, changing FO2 displays and calculations from the FO2 value set for GAS 1 to the FO2 value set for GAS 2 to the FO2 value set for GAS 3, and if TMTs are used, changing Pressure related displays and calculations from TMT 1 (Transmitter 1) to TMT 2 to TMT 3.

△ NOTE: Switching the Elite T3 from one GAS to another cannot be performed while on the surface, during dives when TMT 2-3 USE is set for Buddy Pressure Check, or when operating in GAUG Mode.

Every dive begins with GAS 1. 10 minutes after surfacing from a multiple gas dive, the Elite T3's operation defaults to the GAS 1 FO2.

Access to NORM DIVE Gas Switching screens can only be accomplished during the time that a NORM DIVE MAIN screen is being displayed and cannot be performed during the time that an Alarm is sounding.

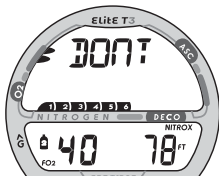

Fig. 87 - DON'T SWITCH
GAS ALARM

△ NOTE: If a Switch to a new Gas Mix would expose the diver to a prohibitive PO2 level of 1.60 ATA or greater, the Audible Alarm will sound, the red LED will flash, and the message DONT > SWCH will scroll at the top of the display (Fig. 87) until acknowledged by depressing the A button for 2 seconds.

Due to the possibility that sufficient air may not be available in the Switch From tank to complete the dive, the Switch to the prohibitive Mix can still be made. If the Switch is made to the prohibitive Mix while in NORM NO DECO DIVE Mode, the High PO2 Alarm will activate. If the Switch is made to the prohibitive Mix while in DECO DIVE Mode, the message HIGH > PO2 will replace the scrolling DECO message until the High PO2 condition clears.

Switching of Gas Mixes can only to be performed during the time that a Gas Switch Preview screen is being displayed. These are accessed from the TMT 2-3 USE screen.

- Depressing the M button for 2 seconds while viewing a NORM DIVE MAIN screen will access the TMT 2-3 USE (Lead-in) screen displaying the Set Point SELF (Fig. 88). If 'bud' is displayed, indicating that the Elite T3 is set for Buddy Pressure Check, a Gas Switch cannot be made.
- Pressing and releasing the M button momentarily (< 2 seconds) while the TMT 2-3 USE screen is displayed (with the setting SELF) will access the GAS 1 Switch Preview screen.
- The Elite T3 will revert to the NORM DIVE MAIN screen after 10 seconds of no further M button action.

When a switch is made to another GAS, there may be a delay of 5 to 15 seconds before the Elite T3's Receiver picks up the TMT's signal.

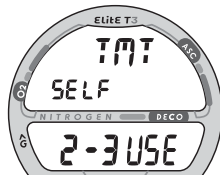

Fig. 88 - GAS SWITCH LEAD-IN

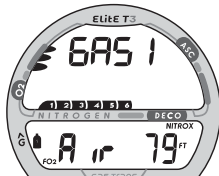

Fig. 89 - GAS 1 SWITCH PREVIEW

GAS 1 SWITCH PREVIEW, information includes (Fig. 89) -

- > Graphic GAS1
- > NIBG, representing Nitrogen Loading
- > VARI, if ascending
- > O2BG, if any
- > FO2 Set Point for GAS 1 and the symbol FO2
- > Tank icon, representing GAS 1
- > Symbol NITROX
- > Current Depth and symbol FT (or M)

- Press/release the M button momentarily (< 2 seconds) to access the GAS 2 Switch Preview Display for 10 seconds.

GAS 2 SWITCH PREVIEW, information includes (Fig. 90) -

- > Graphic GAS2
- > NIBG, representing Nitrogen Loading
- > VARI, if ascending
- > O2BG, if any
- > FO2 Set Point for GAS 2 and the symbol FO2
- > Tank icon representing GAS 2
- > Symbol NITROX
- > Current Depth and symbol FT (or M)

- Press/release the M button momentarily (< 2 seconds) to access the GAS 3 Switch Preview Display for 10 seconds.

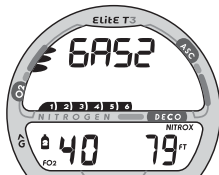

Fig. 90 - GAS 2 SWITCH PREVIEW

TO SWITCH FO2 FROM GAS 1 TO GAS 2

- Depressing the M button for 2 seconds while viewing the GAS 2 Switch Preview Display will Switch the Elite T3's FO2 from GAS 1 to GAS 2 and the Elite T3's Receiver from TMT 1 to TMT 2 (if active).
- After the switch is made, the NORM DIVE MAIN Display will represent GAS 2 (Fig. 91). If TMT 2 is active, Air Time Remaining is then calculated based on Tank 2's Pressure.

When Switching to a GAS (FO2) associated with a Tank that does not have an active TMT, the procedures and displays will be the same without displaying Tank Pressure.

TO SWITCH FO2 FROM GAS 2 BACK TO GAS 1

A Switch Back to FO2 GAS 1 can be performed, as follows:

- Press/release the M button momentarily (< 2 seconds) to step through the Gas Switch Preview screens and access the GAS 1 Switch Preview screen.
- Depress the M button for 2 seconds while the GAS 1 Switch Preview screen is displayed to switch the Elite T3 from GAS 2 back to GAS 1 and the Elite T3's Receiver from TMT 2 back to TMT 1 (if active).
- After the switch is made, the NORM DIVE MAIN Display will represent GAS 1. If TMT 1 is active, Air Time Remaining is then calculated based on Tank 1's Pressure.

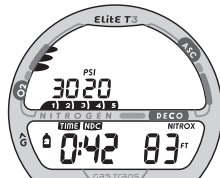

Fig. 91 - NORM DIVE MAIN
(after a Switch to GAS 2)

GAS 3 SWITCH PREVIEW, information includes (Fig. 92) -

- > Graphic GAS3
 - > NIBG, representing Nitrogen Loading
 - > VARI, if ascending
 - > O2BG, if any
 - > FO2 Set Point for GAS 3 and the symbol FO2
 - > Tank icon representing GAS 3
 - > Symbol NITROX
 - > Current Depth and symbol FT (or M)
- Press/release the M button momentarily (< 2 seconds) to access the GAS 1 Switch Preview Display.

TO SWITCH FO2 FROM GAS 2 TO GAS 3

- Depressing the M button for 2 seconds while viewing the GAS 3 Switch Preview Display will Switch the Elite T3's FO2 from GAS 2 to GAS 3 and the Elite T3's Receiver from TMT 2 to TMT 3 (if active).
- When the switch is made, the NORM MAIN DIVE Display will represent GAS 3. If TMT 3 is active, Air Time Remaining is then calculated based on Tank 3's Pressure.
- A Switch Back to FO2 GAS 2 can be performed, as previously described for switching GAS 2 Back to GAS 1.

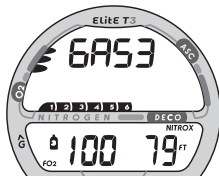

Fig. 92 - GAS 3 SWITCH PREVIEW

BUDDY PRESSURE CHECK (NORM only)

During NORM Dives, the Elite T3 can be used to check (display) Tank Pressure of 1 or 2 buddies whose TMT Link Codes (Serial Numbers) have been entered as TMT 2 and TMT 3 in the Elite T3's SET U menu.

△ NOTE: Use of the Buddy Pressure Check feature cannot be performed when TMT 2-3 USE is set for SELF (Gas Switching) or while operating in GAUG Mode.

Access to Buddy Pressure Check screens during dives can only be accomplished during the time that a NORM DIVE MAIN screen is being displayed and cannot be performed while viewing Alternate displays or during the time that an Alarm is sounding.

BUDDY PRESSURE CHECK DURING DIVES

- Bring the Elite T3 within 3 feet (1 meter) of the Buddy's Transmitter.
- Press and hold the M button for 2 seconds while viewing a NORM DIVE MAIN screen to access the TMT 2-3 USE screen displaying the Set Point bud (Fig. 93). If SELF is displayed, indicating that the Elite T3 is set for FO2 GAS Switching, a Buddy Pressure Check cannot be performed.

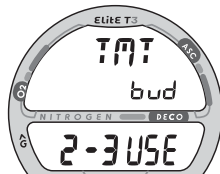

Fig. 93 - BUDDY PRESSURE CHECK LEAD-IN



Fig. 94 - BUDDY SEARCH

- Pressing and releasing the M button momentarily (< 2 seconds) while the TMT 2-3 USE (Lead-in) screen is displayed (with the setting BUD) will start a Search for BUD 1 (TMT 2)) displaying the graphics BUD and SEArCH (Fig. 94) for a maximum of 5 seconds.

⚠ NOTE: No further button action is required. The displays will change automatically, then revert to the NORM DIVE MAIN Display

- After 5 seconds, or less if BUD 1's (TMT 2's) signal is acquired, the BUD 1 screen will appear displaying the graphic BUD1 and BUD 1's Pressure (Fig. 95), or the graphic NotAvAil (Not Available), for 3 seconds.
- After BUD 1's screen has been displayed for 3 seconds, the BUD 2 screen will appear displaying the graphic BUD2 and BUD 2's Pressure, or the graphic NotAvAil for 3 seconds.
- After BUD 2's screen has been displayed for 3 seconds, the screen will revert to the NORM DIVE MAIN Display.



Fig. 95 - BUDDY 1 (TMT 2)
PRESSURE CHECK

△ NOTE: The graphic NotAvAil (Not Available) (Fig. 96) indicates that the Buddy is out of range or the Elite T3's TMT 2 (or 3) setting does not match the Serial Number of that Buddy's TMT.

BUDDY PRESSURE CHECK ON SURFACE

A Buddy Pressure Check can be accomplished when on the Surface by accessing the TMT Status Check screens while the NORM SURF MAIN screen is being displayed.

- Depressing and holding the S button for 2 seconds will activate the Elite T3's Receiver and access the TMT Status screens and Pressures of the Tanks reporting.
- TMT 2 and TMT 3 Battery Status is not displayed when TMT 2-3 USE is set for BUD (Buddy Check).
- If a TMT is not active and linked to the Elite T3, the message NotAvAil (Not Available) will appear.
- Each screen will be displayed for 3 seconds.
- The display will then revert to the NORM SURF MAIN screen.



Fig. 96 - BUDDY 2 (TMT 3)
PRESSURE CHECK

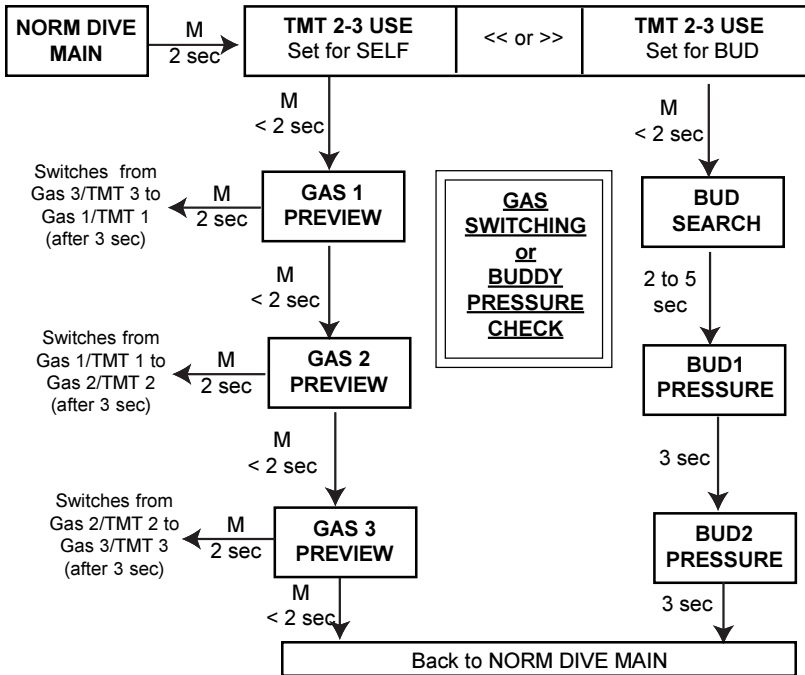



WARNING: Prior to diving with the Elite T3, you must also read and understand the AERIS Dive Computer Safety and Reference Manual, Doc. No. 12-7203, which provides Important Warnings and Safety Recommendations as well as general product information.

NORM POST DIVE MODES

POST DIVE SURFACE MODE

When you ascend to 2 FT (0.6 M), the Elite T3 will enter Surface Mode and begin counting your Surface Interval.

TRANSITION PERIOD

If you descend during the first 10 minutes after surfacing (referred to as the Transition Period), time underwater will be considered a continuation of that dive. The time at the surface (if less than 10 minutes) will not be added as Dive Time.

Transition Period information on the surface includes (Fig. 97):

- > Graphic NORM alternating with the Altitude Level graphic SEA (or LEV2 through LEV13) and WET (if the unit is wet).
- > Battery icon if an Elite T3 Low Battery Warning Condition exists, flashing if Too Low.
- > NIBG, representing Nitrogen loading.
- > O2BG, if a Nitrox dive
- > Tank Pressure with symbol PSI (or BAR), if the Receiver is Linked with an active TMT.
- > Symbol DIVE and Number of that dive.
- > Symbols TIME and SURF, and Surface Interval Time (hr:min).
- > NITROX symbol, if any GAS is set for a Nitrox dive.
- > Tank icon representing the GAS in use.

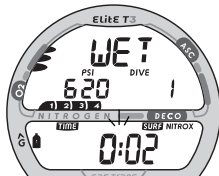

Fig. 97 - TRANSITION PERIOD

During the Transition Period, the SURF ALT and LOG for that dive can be accessed. Other modes (e.g., Plan, Fly, Sat, Hist, Set) will be accessible after 10 minutes on the surface.

SURF ALT Display during the Transition Period (Fig. 98) -

- To access SURF ALT, press and release the A button (< 2 seconds) while viewing the NORM SURF MAIN display.
- Press the S button to activate the SmartGlo Backlight.
- Press and release the A button (< 2 seconds) while viewing the NORM SURF ALT display to access the LOG Preview screen for that dive.
- The screen will revert to NORM SURF MAIN after 2 minutes unless the A button is pressed.

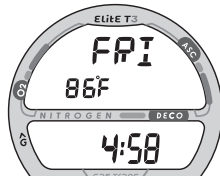

Fig. 98 - NORM SURF ALT

To view that dive's LOG during the Transition Period -

- Press and release the A button 2 times (< 2 seconds each) while viewing the NORM SURF MAIN display to access the LOG Preview screen (Fig. 99).
- Press the S button to view the LOG 1 screen (Nitrogen/ Dive data).
- Press the S button again to view the LOG 2 screen (Oxygen data), if a Nitrox dive.
- Press the S button again to return to the NORM SURF MAIN screen.
- The screen will revert to NORM SURF MAIN after 2 minutes if no button is pressed.

Data for that dive will not be stored in the Eite T3's memory until the 10 minute Transition Period on the surface is completed.

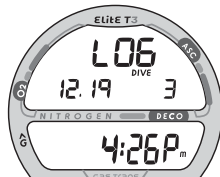

Fig. 99 - LOG PREVIEW
(during Transition Period)

Once 10 minutes have elapsed, the Surface Interval time display colon will stop flashing indicating that the Dive and Transition Period are completed, and a subsequent descent will be considered a new dive.

AFTER THE TRANSITION PERIOD

Once the Transition Period has ended, you will then have full access to other Modes (e.g., GAUG SURF, FREE SURF, PLAN, FLY, SAT, LOG, HISTORY, SET, etc.).

- To activate the SmartGlo Backlight, press the S button.
- To access SURF ALT, PLAN, FLY, etc., press/release the A button as required.

NORM SURF MAIN > GAUG SURF MAIN > FREE SURF MAIN

NORM SURF MAIN > ALT > PLAN > FLY > SAT > LOG > HIST

- > The Planning Sequence now displays adjusted No Decompression Limits based on residual nitrogen and accumulated oxygen calculated to be remaining from the previous dives.
- > The Time to Desaturate counter provides calculated time for tissue desaturation at sea level.
- > If a Violation occurred during the dive, the SAT screen (Desaturation Time) will not be displayed.
- > After 2 hours on the Surface, FLY > SAT > WET (if the Elite T3 is wet) alternate.



WARNING: Prior to diving with the Elite T3, you must also read and understand the AERIS Dive Computer Safety and Reference Manual, Doc. No. 12-7203, which provides Important Warnings and Safety Recommendations as well as general product information.

GAUGE OPERATING MODE

GAUGE MODE

When Gauge Mode (GAUG) is selected as the Operating Mode, the Elite T3 will operate as a Digital Depth Gauge/Timer without performing nitrogen and oxygen calculations.

- To access the GAUG SURF MAIN screen while NORM SURF MAIN is displayed, press the M button for 2 seconds.
- If no GAUG dive has been conducted, press the M button for 2 seconds to access FREE SURF MAIN.

NORM SURF MAIN > GAUG SURF MAIN > FREE SURF MAIN

GAUG SURF MAIN Display (Default),

information provided includes (Fig. 100) -

- > Graphic GAUG alternating with the Altitude Level graphic SEA (or LEV2 through LEV13) and WET (if the unit is wet).
- > Battery icon if an Elite T3 Low Battery Warning Condition exists, flashing if Too Low.
- > Tank Pressure with symbol PSI (or BAR), if the Receiver is Linked with an active TMT.
- > Symbol DIVE and Number of that dive.
- > Symbols TIME and SURF, and Surface Interval Time (hr:min).



Fig. 100 - GAUG SURF MAIN

- Press the S button to activate the SmartGlo Backlight.
- Press/release the A button as necessary to access SURF ALT, FLY, LOG, and HISTORY, similar to NORM Mode.

- Press/hold the A and S buttons simultaneously for 2 seconds to access the SET menu (F > A > U > T).
- Press/hold the S button for 2 seconds to access Battery/TMT Status screens.

Upon descending to 5 FT (1.5 M), the Elite T3 will enter GAUG DIVE Mode.

△ NOTE: Once a dive is made with the Elite T3 set for GAUG Operating Mode, you must wait 24 hours after surfacing before the Elite T3 resets and will operate in NORM Mode (Air or Nitrox) or FREE Dive Mode.

GAUG DIVE MAIN Display (Default),

information provided includes (Fig. 101) -

- > Graphic GAUG.
 - > Tank Pressure with symbol PSI (or BAR), if the Receiver is Linked with an active TMT.
 - > Current Depth and FT (or M) icon.
- Press/release the A button to access GAUG DIVE ALT 1.
 - Depress the A button for 2 seconds to acknowledge/silence Alarms.
 - Press the S button to activate the SmartGlo Backlight.

Gas Switching and Buddy Pressure checks can not be performed in GAUG Mode.

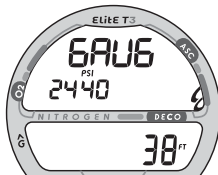

Fig. 101 - GAUG DIVE MAIN



Fig. 102 - GAUG DIVE ALT 1

GAUG DIVE ALT 1 Display,

information provided includes Fig. 102) -

- > Day of the Week graphic (MON, TUE, etc.)
- > Temperature with degrees icon and graphic F (or C)
- > Time of Day (hr:min).

- Press/release the A button (< 2 sec) to view GAUG DIVE ALT 2.
- The display will revert to the GAUG DIVE MAIN Display after 3 seconds unless A is pressed.

GAUG DIVE ALT 2 Display,

information provided includes (Fig. 103) -

- > Graphic TMT1 (or 2 or 3)
- > Tank Pressure with the PSI (or BAR) icon, if TMT 1 is active and linked
- > EDT (hr:min) with symbols DIVE and TIME
- > ATR (hr:min) with symbols AIR and TIME, if TMT 1 is active and linked
- > Max Depth with icons FT (or M) and MAX

- The display will revert to the GAUG DIVE MAIN screen after 3 seconds.

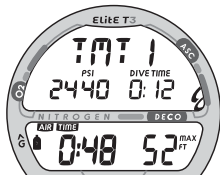

Fig. 103 - GAUG DIVE ALT 2



WARNING: Prior to diving with the Elite T3, you must also read and understand the AERIS Dive Computer Safety and Reference Manual, Doc. No. 12-7203, which provides Important Warnings and Safety Recommendations as well as general product information.

FREE DIVE OPERATING MODE

FREE DIVE MODE

When FREE (Free Dive Mode) is selected as the Operating Mode, the Elite T3 will operate as a Digital Depth Gauge with select features.

Nitrogen loading is calculated based upon a default FO2 of AIR and the amount remaining during 24 hours is carried over between FREE and NORM Operating Modes.

FREE Mode Alarms and their Set Points are independent of those for NORM and GAUG Mode, and they cannot be silenced.

- To access FREE Operating Mode while NORM GAUG MAIN is displayed, depress the M button for 2 seconds.

NORM SURF > GAUG SURF > FREE SURF MAIN

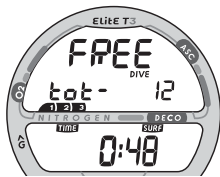

Fig. 104 - FREE SURF MAIN

FREE SURF MAIN DISPLAY, information includes (Fig. 104) -

- > Graphic FREE alternating with the Altitude Level graphic SEA (or EL 2 through EL13) or graphic WET (if wet).
- > Battery icon if an Elite T3 Low Battery Warning Condition exists, flashing if Too Low.
- > Graphic tot - with symbol DIVE and accumulated Total number of repetitive FREE Dives conducted in that series.
- > Symbols TIME and SURF and Surface Interval Time (min:sec up to 59:59, then hr:min).

- Press the S button to activate the SmartGlo Backlight.
- Depress the M button for 2 seconds to access NORM SURF MAIN.
- Press and release the A button momentarily (< 2 seconds) to access FREE SURF ALT 1.
- Press and release the A button momentarily (< 2 seconds) to while viewing ALT 1 to access FREE SURF ALT 2.
- Depress the A button for 2 seconds to access the FREE SURF CDT (CountDown Timer) STATUS screen, allowing you to Set/Start/Stop the Timer.
- Depress the A and S buttons simultaneously for 2 seconds to access the SET FREE EDT (Elapsed Dive Time) ALARM Display from which you can then access the SET FREE DEPTH ALARM 1/2/3 Displays.

FREE SURF ALT 1 Display, information includes (Fig. 105) -

- > Day of the Week graphic (MON, TUE, etc.)
 - > Temperature with degrees icon and graphic F (or C)
 - > Time of Day (hr:min).
- Press and release the A button (< 2 seconds) to view FREE SURF ALT 2.
 - The display will revert to the FREE SURF MAIN screen after 3 seconds unless A is pressed.

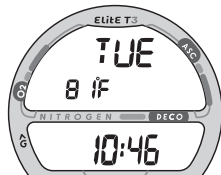

Fig. 105 - FREE SURF ALT 1

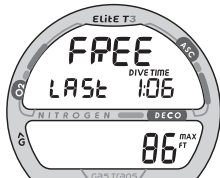

Fig. 106 - FREE SURF ALT 2

FREE SURF ALT 2 Display, information includes (Fig. 106) -

- > Graphic FREE
- > Battery icon if an Elite T3 Low Battery Warning Condition exists, flashing if Too Low.
- > Graphic LAST with symbols DIVE TIME and the Elapsed Dive Time (min:sec) of the FREE dive previously made while still in FREE MODE. Resets to 0:00 after 24 hours.
- > Symbols MAX and FT (or M) and the Maximum Depth of the FREE dive previously made while still in FREE MODE.
- Press the S button to activate the Backlight.



Fig. 107 - FREE SURF CDT STATUS

The display will revert to the FREE SURF MAIN screen after 3 seconds.

FREE MODE COUNTDOWN TIMER (CDT)

Depressing the A button for 2 seconds while viewing the FREE SURF MAIN screen will access the FREE SURF CDT STATUS screen.

FREE SURF CDT STATUS Display,

information includes (Fig. 107) -

- > Graphics TIMR and OFF (or ON), flashing
- > TIME symbol and remaining Countdown time (min:sec) with the colon flashing, if ON and a CD is in progress.
- > 0:00 (min:sec) will be displayed with the colon flashing, if the CD Timer is ON and no time is remaining.

- > If the CD Timer is OFF, the CD Time (min:sec) previously set will be displayed with the colon solid.
- Pressing and releasing the S button momentarily (< 2 seconds) will toggle between ON and OFF.
- > If a Time has been set, a toggle from OFF to ON will start the CD Timer indicated by the colon flashing.
- Press the S button to activate the SmartGlo Backlight.
- Pressing/releasing the A button momentarily (< 2 seconds) will revert the Display to the FREE SURF MAIN screen.
- Depressing the A and S buttons simultaneously for 2 seconds while viewing the CD Timer Status screen when the CD Timer is OFF will access the SET CD TIMER screen with the MINUTE Set Point flashing.

△ NOTES: Once the CD TIMER has been Set and Started (by selecting ON), it will continue to run in the background while on the surface until turned OFF (stopped) or the Time reaches 0:00 at which time the Alarm will strike (3 short beeps 3 times), the message TIMR will be displayed, and the CD TIMER will revert to OFF.

Upon descending to 5 FT/1.5 M for 5 seconds (i.e., entry into FREE DIVE Mode), CD TIMER operation will continue, if in progress.

During a dive, the CD TIMER can be turned OFF (stopped) and ON (started), but not Set.

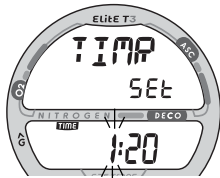

Fig. 108 - SET FREE CDT

SET FREE CDT STATUS Display (Surface only),

information includes (Fig. 108) -

- > Graphics TIMR and SEt, solid.
 - > TIME symbol and Timer setting (min:sec), colon solid, MINUTE Set Point flashing.
- Depressing and holding the S button while the MINUTE Set Point is flashing will scroll through the Set Points at a rate of 4 per second from 0: to 59: in 1 Minute (1:) increments.
 - Pressing and releasing the A button momentarily (< 2 seconds) will save the MINUTE Set Point displayed and advance to Set SECONDS with the Set Point flashing.
 - Depressing and holding the S button while the SECONDS Set Point is flashing will scroll through the Set Points at a rate of 4 per second from :00 to :59 in 1 Second (:01) increments.
 - Pressing and releasing the A button momentarily (< 2 seconds) will save the CD Timer Set Point indicated by the graphic OFF flashing (Fig. 109) in place of the graphic SET.
 - Pressing and releasing S button momentarily (< 2 seconds) will toggle to ON and Start the CD TIMER.
 - Pressing the A button momentarily (< 2 seconds, or if the M button is depressed for 2 seconds, or if no button is pressed during a period of 2 minutes, the Display will revert to the FREE SURF MAIN screen.



Fig. 109 - FREE CDT SET
(ready to Start)

FREE DIVE EDT (ELAPSED DIVE TIME) ALARM

The FREE EDT Alarm is factory set for 30 seconds. When set ON, the Alarm will sound 3 short beeps and the message TIME will be displayed momentarily every 30 seconds while the Elite T3 is operating underwater in FREE DIVE Mode.

- Depressing the A and S buttons simultaneously for 2 seconds while the FREE SURF MAIN screen is displayed, will access SET FREE EDT ALARM with the Set Point flashing.

△ NOTE: The FREE EDT Alarm can only be Set (turned OFF or ON) while on the Surface and can not be changed during a Dive.

SET FREE EDT ALARM Display, information includes (Fig. 110) -

- > Graphic EDT.
- > Set Point OFF or ON, flashing.
- Pressing and releasing the S button momentarily (< 2 seconds) will toggle the Set Point between OFF and ON.
- Pressing the A button momentarily (< 2 seconds) will accept the setting and access the SET FREE DEPTH ALARM 1 screen.
- Depressing the M button for 2 seconds, or if no button is pressed during a period of 2 minutes, the display will revert to the FREE SURF MAIN screen.

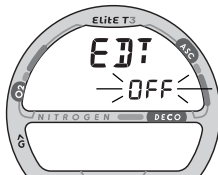

Fig. 110 - SET FREE EDT ALARM

FREE DIVE DEPTH ALARMS (FDA)

The Elite T3 features 3 FREE Dive DEPTH Alarms that can be Set at progressively deeper Depths and turned OFF/ON.

- > If Alarm 1 is set OFF, then Alarms 2 and 3 will be disabled.
- > If Alarm 2 is set OFF, Alarm 3 will be disabled.

When each of the Depths are reached during a dive, 3 short beeps will sound 3 times and the message DPTH will be displayed 3 times.

- Pressing the A button momentarily (< 2 seconds) while the SET FREE EDT ALARM screen is displayed will access SET FREE DEPTH ALARM 1 with the Set Point flashing.

Sequence of FREE Mode Alarm Setting Access:

FREE SURF MAIN • press A and S 2 seconds >>>>
SET FREE EDT AL • press A less than 2 seconds >>>>
SET FREE DEPTH AL 1 • press A less than 2 seconds >>>>
SET FREE DEPTH AL 2 • press A less than 2 seconds >>>>
SET FREE DEPTH AL 3 • press A less than 2 seconds >>>>
FREE SURF MAIN



SET FREE DEPTH ALARM 1 (FDA 1) Display,

information includes (Fig. 111) -

- > Graphic FDA 1.
 - > Set Point ON or OFF, flashing.
 - > Depth Set Point graphic value, flashing if ON is displayed.
 - > Symbols MAX and FT (or M).
-
- Pressing and releasing the S button momentarily (< 2 seconds) will toggle the Set Point between ON and OFF.
 - > If set ON, the Depth value displayed will flash.
 - Pressing and releasing the S button momentarily and repeatedly (< 2 seconds each time) will step through the Set Points from 30 to 330 FT (10 to 100 M) in increments of 10 FT (1 M) at a rate of 1 Set Point per press of the button.
 - Pressing and holding the S button will scroll through the Set Points at a rate of 4 Set Points per second until released.
 - Pressing the A button momentarily (< 2 seconds) will accept the Depth Setting and advance to SET FREE DEPTH ALARM 2.
 - If set OFF, pressing the A button momentarily will accept the Setting and revert operation to the FREE SURF MAIN screen, bypassing SET FREE DEPTH ALARMS 2 and 3.
 - Depressing the M button for 2 seconds, or if no button is pressed during a period of 2 minutes, the display will revert to the FREE SURF MAIN screen.

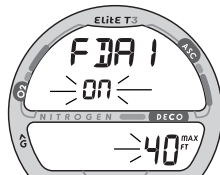

Fig. 111 - SET FREE DEPTH ALARM 1

NOTE: The range of available FDA 2 Set Points begins at the next FT/M value greater than the FDA 1 Alarm Set Point.

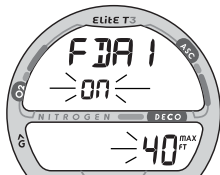

Fig. 112 - SET FREE DEPTH ALARM 2

SET FREE DEPTH ALARM 2 (FDA 2) Display,

information includes (Fig. 112) -

- > Graphic FDA2.
 - > Set Point ON or OFF, flashing.
 - > Depth Set Point graphic value, flashing if ON is displayed.
 - > Symbols MAX and FT (or M).
-
- Pressing and releasing the S button momentarily (< 2 seconds) will toggle the Set Point between ON and OFF.
 - > If set ON, the Depth value displayed will flash.
 - Pressing and releasing the S button momentarily and repeatedly (< 2 seconds each time) will step through the Set Points from 40 to 330 FT (11 to 100 M) in increments of 10 FT (1 M) at a rate of 1 Set Point per press of the button.
 - Pressing and holding the S button will scroll through the Set Points at a rate of 4 Set Points per second until released.
 - Pressing the A button momentarily (< 2 seconds) will accept the Depth Setting and advance to SET FREE DEPTH ALARM 3.
 - If set OFF, pressing the A button momentarily will accept the Setting and revert operation to the FREE SURF MAIN screen, bypassing SET FREE DEPTH ALARM 3.
 - Depressing the M button for 2 seconds, or if no button is pressed during a period of 2 minutes, the display will revert to the FREE SURF MAIN screen.

SET FREE DEPTH ALARM 3 (FDA3) Display,

information includes (Fig. 113) -

- > Graphic FDA3.
 - > Set Point ON or OFF, flashing.
 - > Depth Set Point graphic value, flashing if ON is displayed.
 - > Symbols MAX and FT (or M).
-
- Pressing and releasing the S button momentarily (< 2 seconds) will toggle the Set Point between ON and OFF.
 - > If set ON, the Depth value displayed will flash.
 - Pressing and releasing the S button momentarily and repeatedly (< 2 sec each time) will step through the Set Points from 50 to 330 FT (12 to 100 M) in increments of 10 FT (1 M) at a rate of 1 Set Point per press of the button.
 - Pressing and holding the S button will scroll through the Set Points at a rate of 4 Set Points per second until released.
 - Pressing the A button momentarily (< 2 sec) will accept the Depth Setting and advance to SET FREE DEPTH ALARM 3.
 - If set OFF, pressing the A button momentarily will accept the Setting and revert operation to the FREE SURF MAIN screen.
-
- Depressing the M button for 2 seconds, or if no button is pressed during a period of 2 minutes, the display will revert to the FREE SURF MAIN screen.

NOTE: The range of available FDA 3 Set Points begins at the next FT/M value greater than the FDA 2 Alarm Set Point.

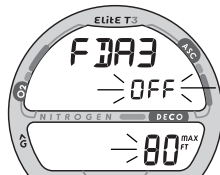

Fig. 113 - SET FREE DEPTH ALARM 3



Fig. 114 - FREE DIVE MAIN

FREE DIVE MAIN Display (Default),

information includes (Fig. 114) -

- > Graphic FREE
- > NIBG, if any Nitrogen remaining from previous NORM or FREE Dives conducted within the previous 24 hours.
- > Temperature with degrees symbol and graphic F (or C)
- > Symbols DIVE and TIME and Elapsed Dive Time (min:sec).
- > Current Depth and symbol FT (or M).

- Press and release the A button momentarily (< 2 seconds) to access the FREE DIVE ALT screen for 3 seconds.
- Depress the A button for 2 seconds to access the FREE CDT (Count Down Timer) STATUS screen.
- Press the S button to activate the SmartGlo Backlight.

FREE DIVE ALT Display, information includes (Fig. 115) -

- > Day of the Week graphic (MON, TUE, etc.)
- > Temperature with degrees icon and graphic F (or C)
- > Time of Day (hr:min).

- The display will revert to the FREE DIVE MAIN screen after 3 seconds.



Fig. 115 - FREE DIVE ALT

FREE DIVE CDT STATUS Display,

information includes (Fig. 116) -

- > Graphics TIMR and OFF (or ON), flashing
 - > TIME symbol and remaining Countdown time (min:sec) with the colon flashing if ON and a CD is in progress, 0:00 with the colon flashing if ON and no time is remaining. If OFF, the CD Time previously set while on the surface is to be displayed with the colon solid.
- Pressing and releasing the S button momentarily (< 2 seconds) will toggle between OFF and ON. If a Time has been set, a toggle from OFF to ON will Start the CD TIMER indicated by the colon flashing (Fig. 117).
 - Pressing the S button will activate the SmartGlo Backlight.
 - Pressing and releasing the A button momentarily (< 2 seconds) will revert to the FREE DIVE MAIN screen.
 - If no button is pressed during a period of 10 seconds, the display will revert to the FREE DIVE MAIN screen.

FREE DIVE ALARMS

All FREE Dive Alarms will sound 3 short beeps (1 or 2 times) and display a graphic Message as an indication that an event is occurring and as a reminder to view the display to identify the event. After the beeps have sounded, the Alarm Message will be replaced with the graphic FREE.



Fig. 116 - FREE DIVE CDT STATUS (OFF, ready to Start)

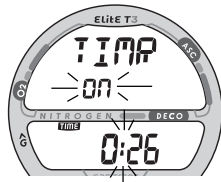

Fig. 117 - FREE DIVE CDT STATUS (ON, Running)

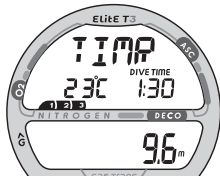

Fig. 118 - FREE DIVE MAIN
(During CDT ALARM)

FREE DIVE Alarms are separate and unaffected by NORM/GAUG Mode Alarm Settings, and the Alarms that occur in those Modes are separate and unaffected by FREE DIVE Alarm Settings.

FREE CDT (Count Down Timer) ALARM

When the FREE CDT decreases to 0:00 (min:sec), 3 short beeps will sound 3 times, the red LED will flash, and the Message TIMR will appear on the display 3 times momentarily (Fig. 118), then revert to the Message FREE.

FREE DIVE DEPTH ALARM(S)

When Depth reaches the FREE DEPTH ALARM 1 Set Point, 3 short beeps will sound 3 times, the red LED will flash, and the Message DPTH will appear on the display 3 times momentarily (Fig. 119), then revert to the Message FREE.

The beeps and Message will be repeated when Depth reaches the FREE DEPTH ALARM 2 and 3 Set Points, if set ON.

If Ascent is made above a FREE DEPTH ALARM Set Point and then a descent is made to a Depth below it, the respective Depth Alarm will sound again.

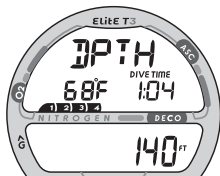

Fig. 119 - FREE DIVE MAIN
(During DEPTH ALARM)

FREE DIVE EDT (Elapsed Dive Time) ALARM

When the FREE EDT Alarm is set ON prior to commencing a FREE Dive, 3 short beeps will sound, the red LED will flash, and the Message TIME will appear on the display momentarily (Fig. 120), then revert to the Message FREE.

This FREE DIVE Alarm is factory set to repeat every 30 seconds during FREE DIVE Mode, when it is set ON prior to the dive.

FREE DIVE NIBG (Nitrogen Loading Bar Graph) ALARM

While diving in FREE DIVE Mode, nitrogen accumulation from the FREE Dives in that set and any previous NORM Dives conducted within 24 hours is displayed as the NIBG.

When Nitrogen Loading increases to the Caution level indicated by 7 segments displayed as the NIBG and the UP Arrow appearing solid, 3 short beeps will sound 3 times, the red LED will flash, and the Message UP > HIGH > NI will appear on the display (Fig. 121).

After the beeps, the Message will continue to scroll until the NIBG recedes to 6 segments at which time the Message will change to FREE and the UP Arrow will be removed.

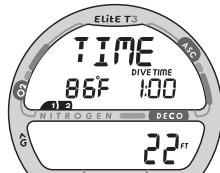

Fig. 120 - FREE DIVE MAIN
(During EDT ALARM)

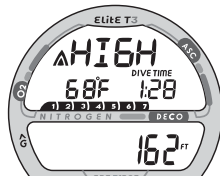

Fig. 121 - FREE DIVE MAIN
(During NIBG ALARM)



flashing
Fig. 122 - FREE DIVE MAIN
(During DECO)

ENTRY INTO DECO DURING A FREE DIVE

In the event that Nitrogen Loading increases to the Warning level indicated by all segments of the NIBG and O2BG and UP Arrow flashing, 3 short beeps will sound 3 times, the red LED will flash, and the Message UP > VIOL will appear on the display (Fig. 122).

After the beeps, the message UP > VIOL will continue to be displayed scrolling until you surface, then the graphic VIOL will alternately be On/Off for 10 minutes after the dive.

Upon surfacing, the UP Arrow will be removed, however, the Full NIBG and O2BG will continue to flash for 24 hours (Fig. 123).

Operation will be as Permanent Violation Mode and not access to NORM and GAUG Modes will be blocked until a full 24 hours elapse with no diving.

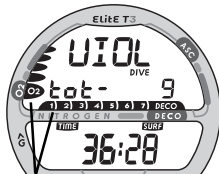

flashing
Fig. 123 - FREE SURF MAIN
(During DECO)

NOTES:
 ▲ **Nitrogen (NIBG) and Oxygen (O2BG) are carried over between FREE and NORM Modes.**

Dive Time Remaining (until Deco or High O2) is calculated during FREE Mode based FO2 of Air, but not displayed.



WARNING: Prior to diving with the Elite T3, you must also read and understand the AERIS Dive Computer Safety and Reference Manual, Doc. No. 12-7203, which provides Important Warnings and Safety Recommendations as well as general product information.

REFERENCE

UPLOADING SETTINGS AND DOWNLOADING DATA

The Elite T3 is configured with a Data Port located on the back of the left side that enables it to be connected to a PC through a USB port using the special Interface Cable supplied.

A USB Driver is provided on the AERIS Computer Interface program CD as part of the Interface System.

The Settings Upload feature can be used to set/change the Elite T3's Set A group (Alarms), Set U group (Utilities), and Set T group (Date/Time) using the Interface System. The Set F group (FO2) and FREE Mode Alarms must be entered using the VT3's control buttons.

Information available for retrieval (Download) from the Elite T3 to the PC OceanLog program includes dive number, surface interval time, maximum depth, elapsed dive time, start date, start time, lowest temperature under water, sampling rate, dive profile, Elite T3's set points, pressure, Air Time Remaining, OTU, OTS, ascent rate, NIBG, O2BG, and Gas Switching events/pressures/FO2s.

The Elite T3 checks for the presence of an interface device connection to the Data Port once every second while in Surface Mode. Checks are not made if the Wet Activation contacts are wet. Upon sensing an interface connection, the requesting device (PC) connects to the Elite T3 and is prepared for Upload of settings or Download of data which are then initiated using the AERIS Computer Interface program.

Prior to attempting to Download data from your Elite T3 or Upload Settings to it, review the HELP section of the AERIS Computer Interface program. Recommended is to print those sections of HELP that you consider appropriate for your Interface activities.

PC compatibility requirements:

- IBM[®], or compatible, Personal Computer with USB Port
- Intel[®] Pentium 200 MHz or better microprocessor
- Microsoft[®] Windows[®] 98 Second Edition, ME, NT, 2000, or XP
- Super VGA card or compatible video graphics adaptor (256 color or greater) with a minimum 800 X 600 pixel screen area of display settings
- 16MB of available RAM
- 20MB of available hard drive storage
- Mouse
- CD Rom drive
- Printer (optional)

For software updates, refer to the AERIS web site.

www.diveaeris.com

For support, call AERIS Computer Interface program Support toll free at -

(866) 732-7877, 8 Am to 5 Pm Pacific time.

CARE AND CLEANING

Protect your Elite T3 from shock, excessive temperatures, exposure to chemicals, and tampering. Protect the lens against scratches with a Instrument Lens Protector. Small scratches will naturally disappear underwater.

- Soak and rinse the Elite T3 in fresh water at the end of each day of diving, and check to ensure that the areas around the Low Pressure (Depth) Sensor (Fig. 124a), PC Interface Data Port (Fig. 124b), and Buttons are free of debris or obstructions. Soak and rinse the Regulator(s) with the Transmitter(s) attached.
- To dissolve salt crystals, use lukewarm water or a slightly acidic bath (50% white vinegar/50% fresh water). After removal from the bath, place the Elite T3 and the Regulator(s) with Transmitter(s) unit under gently running water and towel dry before storing.
- Transport your Elite T3 system cool, dry, and protected.



Fig. 124 - Elite T3 CASE BACK

INSPECTIONS AND SERVICE

Your Elite T3 should be inspected annually by an Authorized AERIS Dealer who will perform a factory prescribed function check and inspection for damage or wear. To keep the 2 year limited warranty in effect, this inspection must be completed one year after purchase (+/- 30 days).

AERIS recommends that you continue to have an inspection performed every year to ensure it is working properly. The costs of annual inspections are not covered under the terms of the 2 year limited warranty.

To Obtain Service:

Take your Elite T3 system to an Authorized AERIS Dealer.

To return your Elite T3 system to AERIS:

- Record all dive data in the Log and/or download the data in memory. All data will be erased during factory service.
- Package it using a protective cushioning material.
- Include a legible note stating the specific reason for return, your name, address, daytime phone number, serial number(s), and a copy of your original sales receipt and Warranty Registration Card.
- Send freight prepaid and insured using a traceable method to AERIS.
- When shipping to AERIS, obtain an RA (Return Authorization) number by contacting AERIS at 510/346-0010 or send an e-mail to service@oceanicusa.com.
- Non-warranty service must be prepaid. COD is not accepted.
- Additional information is available at the AERIS web site diveaeris.com.

BATTERY REPLACEMENT

 **NOTE: The procedures that follow must be closely adhered to. Damage due to improper Battery replacement is not covered by the Elite T3's 2 year warranty.**

When replacing the Battery in the Elite T3, it is recommended that you also replace the Battery(s) in the Transmitter(s), and vice-versa.

The Battery Compartment(s) should only be opened in a dry and clean environment with extreme care taken to prevent the entrance of moisture or dust.

As an additional precautionary measure to prevent formation of moisture in the Battery Compartment(s), it is recommended that the Battery(s) be changed in an environment equivalent to the local outdoor temperature and humidity (e.g., do not change the Battery(s) in an air conditioned environment then take it outside during a hot sunny day).

Inspect the Buttons, Lens, and Housing(s) to ensure they are not cracked or damaged. If there is any sign of moisture in the Elite T3 or Transmitter(s), DO NOT attempt to use the Elite T3 for diving (NORM, GAUG, or FREE) until it receives proper service by the AERIS factory.

Hot Swap

If the new Battery can be inserted into the Elite T3 within 8 seconds after the old one is removed (referred to as a Hot Swap), settings and nitrogen and oxygen calculations for repetitive dives will be retained.

Elite T3 Battery Hatch Removal

- Locate the Battery Compartment on the back of the module.
- While applying steady inward pressure on the clear Battery Hatch, rotate the Hatch Ring clockwise 10 degrees by pressing on the upper/right arm of the Ring with a small blade screwdriver (Fig. 125).

△ NOTE: If available, an adjustable face spanner tool or pointed pliers can be used by inserting the tips of the tool in the small holes in the Ring (Fig. 126).

- Lift the Hatch Ring up and away from the Housing.
- Remove the clear Battery Hatch.

Elite T3 Battery Removal

- Remove the Retaining Bar located across the lower portion of the Battery (Fig. 127a).
- Remove the Hatch O-ring. DO NOT use tools
- Using care not to damage the Battery Contacts (Fig. 127 b/c), slide the Battery up and out of the right side of the Battery Compartment.

△ NOTE: DO NOT allow a metal object to short circuit the top of the Battery which is positive (+) to the negative (-) contact of the Compartment.



Fig. 125 - BATTERY HATCH REMOVAL (Tool)



Fig. 126 - ALTERNATE HATCH REMOVAL

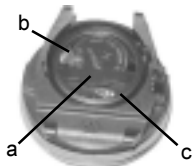

Fig. 127 - Elite T3 BATTERY REMOVAL

Transmitter Battery Removal

Locate the Battery Hatch on the End of the Housing:

- Apply a coin to the recessed slot of the Hatch and turn it counter clockwise out of the Housing (Fig. 128).
- Remove the Battery from the Battery Compartment and discard according to local regulations governing disposal of Lithium batteries.

Elite T3 and Transmitter Inspection

- Closely check all of the sealing surfaces for any signs of damage that might impair proper sealing.
- Inspect the Buttons, Lens, and Housing(s) to ensure they are not cracked or damaged.



WARNING: If damage or corrosion is found, return your Elite T3 system to an Authorized AERIS Dealer, and DO NOT attempt to use it until it has received factory prescribed service.

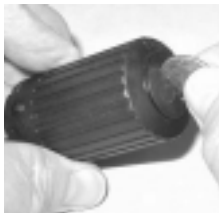

Fig. 128 - TMT BATTERY HATCH REMOVAL

- Remove the Battery Hatch O-ring(s) and inspect them for any signs of deterioration or deformity. DO NOT use tools to remove the O-ring(s).
- To ensure proper sealing, O-ring replacement is highly recommended each time a Battery is replaced.
- Closely examine all threads for any signs of damage that might prevent proper threading.

Inspection (continued) -

- Closely examine the inside of the Battery Compartment(s) for any signs of corrosion indicating entrance of moisture into the unit.
- If corrosion is found, return the Elite T3 system to an Authorized AERIS Dealer, and DO NOT attempt to use it until it has received factory service.
- If moisture is found, it is best to have the unit inspected and cleaned by an Authorized AERIS Dealer.
- If it is necessary to clean the Battery Compartment, flush it and all components with a solution of 50% white vinegar and 50% fresh water. Rinse with fresh water, and allow to dry overnight, or blow dry with a hair dryer set at no heat.

Elite T3 Battery Installation

- Slide a new 3 volt type CR2450 Lithium Battery, negative (-) side down into the Battery Cavity. Slide it in from the right side and ensure that it slides under the contact clip on the left rim of the cavity.
- Orient the Retaining Bar across the lower portion of the Battery and carefully push it down into position.
- Replace the Hatch O-ring with a new one. This O-ring must be a genuine AERIS part that can be purchased from an Authorized AERIS Dealer. Use of any other O-ring will void the warranty.
- Lightly lubricate the **new** Hatch O-ring with silicone grease and place it on the inner rim of the Battery Hatch. Ensure that it is evenly seated.
- Slide the Hatch Ring, top portion first (small opening), onto your thumb (Fig. 129).



Fig. 129 - Elite T3 BATTERY INSTALLATION



Fig. 130 - TIGHTENING
Elite T3 HATCH RING

Elite T3 Battery Installation (continued) -

- Carefully place the clear Battery Hatch (with O-ring) into position on the rim of the Battery Compartment, then press it evenly and completely down into place with your same thumb.
- Maintain the Battery Hatch securely in place and, using your other hand, slide the Hatch Ring down off your thumb and into position around the Battery Compartment. The tabs on the Ring fit down into the slots located at the 2 and 9 o'clock positions.
- Using your fingers, turn the Ring counter clockwise 5 degrees until the tabs engage, then tighten it 5 more degrees by turning it counter clockwise with the aide of a small blade screwdriver or spanner tool, pressing against the upper/left arm of the Ring (Fig. 130).

Transmitter Battery Installation

- Lightly lubricate the new Battery Cap O-ring with silicone grease and install it onto the Battery Cap. DO NOT roll the O-ring over the Threads, instead stretch it slightly to work it down over the slotted end of the Cap into the Groove at the Base of the Threads (Fig. 131).



Fig. 131 - TRANSMITTER
O-RING INSTALLATION

△ NOTE: The Transmitter's O-ring must be a genuine AERIS part that can be purchased from an Authorized AERIS Dealer.

Transmitter Battery Installation (continued) -

- Place a new 3 volt, CR2, Lithium Battery (Duracell model DL-CR2 or equivalent) positive (+) side down into the Battery Compartment with the negative end facing up/out (Fig. 132).
- Ensure that the Battery is properly oriented and the Hatch O-ring is evenly seated around the Battery Hatch.
- Carefully place the Battery Hatch with Spring into the Housing and turn clockwise slowly by hand to ensure proper threading. Apply a coin and tighten until secure. The outer surface of the Battery Hatch should be flush with the outer surface of the Housing (Fig. 133).

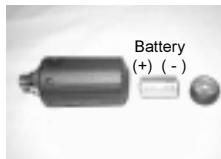

Fig. 132 - TMT BATTERY ORIENTATION

Elite T3 System Testing

- Pressurize the Regulator Assembly (and Transmitter).
- Activate the Elite T3 and watch carefully as it performs a full diagnostic and battery check, and enters Surface Mode. Observe the LCD display to ensure it is consistently clear and sharp in contrast throughout the screen.
- If any portions of the display are missing or appear dim, or if a Low Battery Condition is indicated, return your Elite T3 to an Authorized AERIS Dealer for a complete evaluation before attempting to use it.
- Verify that Tank Pressure is displayed.
- Verify all Set Points prior to diving.
- Press the S button for 2 seconds to check the Status screens.



Fig. 133 - TMT BATTERY HATCH INSTALLED

INSTALLING A TRANSMITTER ON A REGULATOR

To install the Transmitter on the Regulator First Stage:

- Remove the existing Pressure Gauge and High Pressure Hose, or the High Pressure Port Plug from the Port marked HP using the proper size Hex Key.
- Lightly lubricate the O-ring and Threads of the Transmitter fitting with a halocarbon based lubricant such as Christo-Lube MCG 111 (provided in AERIS Battery Kits).
- Thread the Transmitter clockwise by hand into the Regulator's HP Port (Fig. 134) and tighten until secure with a 5/8" open-end wrench.
- Attach the Regulator First Stage to a full Scuba Tank and pressurize by slowly opening the Tank Valve, listening for any indication of air leaking around the Fitting.
- If air leakage is present, DO NOT use, take the complete Regulator Assembly to an Authorized AERIS dealer for inspection and service.



Fig. 134 -INSTALLING A
TMT ON A REGULATOR

TRANSMITTER COMPATIBILITY WITH NITROX

When packaged and shipped from the factory, AERIS Elite T3 Transmitters are rated for use with compressed Air and/or nitrogen-oxygen (Nitrox) breathing gas mixtures containing up to 99% O₂ by volume and with 100% O₂.

ALTITUDE SENSING AND ADJUSTMENT

Prior to the first dive of a series of repetitive dives, ALTITUDE (i.e., Ambient Pressure) is measured upon activation and every 15 minutes until a dive is made.

- > Measurements are taken every 15 minutes during the 24 hour period after surfacing.
- > Measurements are only taken when the unit is dry.
- > Two readings are taken, the second reading 5 seconds after the first. The readings must be within 1 foot (30 cm) of each other to record that Ambient Pressure as the current ALTITUDE.

The Mathematical Model in the Elite T3 accounts for the reduced No Decompression dive Time available based on National Oceanic and Atmospheric Administration (NOAA) guidelines.

When diving in high altitude waters from 2,000 to 14,000 feet (610 to 4,270 meters), the Elite T3 automatically adjusts to these conditions providing corrected Depth, reduced No Decompression Times, and reduced Oxygen Accumulation Times at intervals of 1,000 feet (305 meters).

No adjustments are made during any time that the Wet Contacts are bridged.

At an elevation of 2,000 feet (610 meters), Depth Calibration automatically changes from feet of seawater to feet of fresh water. This is the first adjustment to the Algorithm.

When the Conservative Factor feature is set ON, allowable dive times are calculated based upon the next higher 3,000 foot (915 meter) Altitude. All adjustments for Altitudes greater than 11,000 feet (3,355 meters) are then made to allowable dive times for 14,000 feet (4,270 meters). If the Conservative Factor is set ON while at Sea Level, calculations are based upon an Altitude of 3,000 feet.

The Elite T3 will not function above 14,000 feet (4,270 meters).

IMPERIAL NO DECOMPRESSION LIMITS (HOURS:MINUTES) AT ALTITUDE

Altitude [feet]	0'	2001'	3001'	4001'	5001'	6001'	7001'	8001'	9001'	10001'	11001'	12001'	13001'
	to 2000'	to 3000'	to 4000'	to 5000'	to 6000'	to 7000'	to 8000'	to 9000'	to 10000'	to 11000'	to 12000'	to 13000'	to 14000'
Depth [feet]													
30	4:20	3:35	3:21	3:07	2:55	2:45	2:36	2:28	2:21	2:15	2:10	2:04	1:58
40	2:17	1:53	1:43	1:36	1:30	1:25	1:20	1:16	1:12	1:09	1:06	1:03	1:01
50	1:21	1:07	1:03	1:00	0:58	0:55	0:52	0:48	0:45	0:43	0:41	0:39	0:37
60	0:57	0:46	0:43	0:40	0:38	0:36	0:34	0:33	0:31	0:30	0:29	0:28	0:27
70	0:40	0:33	0:31	0:30	0:28	0:27	0:26	0:24	0:23	0:22	0:20	0:19	0:18
80	0:30	0:26	0:24	0:23	0:21	0:20	0:19	0:18	0:17	0:16	0:16	0:14	0:13
90	0:24	0:20	0:19	0:18	0:17	0:16	0:15	0:14	0:13	0:12	0:11	0:10	0:10
100	0:19	0:16	0:15	0:14	0:13	0:12	0:11	0:10	0:10	0:09	0:09	0:08	0:08
110	0:16	0:13	0:12	0:11	0:10	0:09	0:09	0:08	0:08	0:08	0:08	0:07	0:07
120	0:13	0:10	0:09	0:09	0:08	0:08	0:08	0:07	0:07	0:07	0:06	0:06	0:06
130	0:11	0:09	0:08	0:08	0:07	0:07	0:07	0:06	0:06	0:06	0:06	0:05	0:05
140	0:09	0:07	0:07	0:07	0:06	0:06	0:06	0:06	0:06	0:05	0:05	0:05	0:05
150	0:08	0:07	0:06	0:06	0:06	0:05	0:05	0:05	0:05	0:05	0:04	0:04	0:04
160	0:07	0:06	0:06	0:05	0:05	0:05	0:05	0:05	0:04	0:04	0:04	0:04	0:04
170	0:07	0:05	0:05	0:05	0:05	0:04	0:04	0:04	0:04	0:04	0:04	0:04	0:03
180	0:06	0:05	0:05	0:05	0:04	0:04	0:04	0:04	0:04	0:04	0:03	0:03	0:03
190	0:05	0:05	0:04	0:04	0:04	0:04	0:04	0:04	0:03	0:03	0:03	0:03	0:03

METRIC NO DECOMPRESSION LIMITS (HOURS:MINUTES) AT ALTITUDE

Altitude [meters]	0'	611'	916'	1221'	1526'	1831'	2136'	2441'	2746'	3051'	3356'	3661'	3966'	
	to 610'	to 915'	to 1220'	to 1525'	to 1830'	to 2135'	to 2440'	to 2745'	to 3050'	to 3355'	to 3660'	to 3965'	to 4270'	
Depth [meters]	9	4:43	3:51	3:37	3:24	3:10	2:58	2:48	2:39	2:31	2:24	2:18	2:12	2:07
12	2:24	2:03	1:52	1:44	1:37	1:30	1:25	1:21	1:17	1:13	1:10	1:07	1:04	
15	1:25	1:10	1:06	1:03	1:00	0:57	0:55	0:52	0:49	0:46	0:43	0:41	0:39	
18	0:59	0:49	0:45	0:42	0:40	0:38	0:36	0:34	0:32	0:31	0:30	0:29	0:28	
21	0:41	0:34	0:33	0:31	0:29	0:28	0:27	0:26	0:24	0:23	0:21	0:20	0:19	
24	0:32	0:27	0:26	0:24	0:22	0:21	0:20	0:19	0:18	0:17	0:16	0:15	0:14	
27	0:25	0:21	0:19	0:18	0:17	0:16	0:16	0:14	0:13	0:12	0:12	0:11	0:10	
30	0:20	0:17	0:16	0:15	0:13	0:12	0:12	0:11	0:10	0:10	0:09	0:09	0:08	
33	0:17	0:14	0:12	0:11	0:11	0:10	0:09	0:09	0:08	0:08	0:08	0:07	0:07	
36	0:14	0:11	0:10	0:09	0:09	0:08	0:08	0:07	0:07	0:07	0:06	0:06	0:06	
39	0:11	0:09	0:08	0:08	0:07	0:07	0:07	0:06	0:06	0:06	0:06	0:05	0:05	
42	0:09	0:08	0:07	0:07	0:07	0:06	0:06	0:06	0:05	0:05	0:05	0:05	0:05	
45	0:08	0:07	0:06	0:06	0:06	0:06	0:05	0:05	0:05	0:05	0:05	0:04	0:04	
48	0:07	0:06	0:06	0:06	0:05	0:05	0:05	0:05	0:04	0:04	0:04	0:04	0:04	
51	0:06	0:06	0:05	0:05	0:05	0:05	0:04	0:04	0:04	0:04	0:04	0:04	0:04	
54	0:06	0:05	0:05	0:05	0:05	0:04	0:04	0:04	0:04	0:04	0:03	0:03	0:03	
57	0:05	0:05	0:04	0:04	0:04	0:04	0:04	0:04	0:03	0:03	0:03	0:03	0:03	

**OXYGEN EXPOSURE LIMITS
(from NOAA Diving Manual)**

PO2 [ATA]	Max Duration Single Exposure		Max Total Duration 24 Hour Day	
	[min]	[hr]	[min]	[hr]
0.60	720	12.0	720	12.0
0.70	570	9.5	570	9.5
0.80	450	7.5	450	7.5
0.90	360	6.0	360	6.0
1.00	300	5.0	300	5.0
1.10	240	4.0	270	4.5
1.20	210	3.5	240	4.0
1.30	180	3.0	210	3.5
1.40	150	2.5	180	3.0
1.50	120	2.0	180	3.0
1.60	45	.75	150	2.0

SPECIFICATIONS

CAN BE USED AS

- Dive Computer (Air or Nitrox)
- Digital Depth Gauge/Timer
- Free Dive activity
- With or without up to 3 Transmitters

NO DECOMPRESSION MODEL

Basis:

- Modified Haldanean Algorithm
- 12 tissue compartments

Data Base:

- Diving Science and Technology (DSAT) - Rogers/Powell

Dive Computer Performance:

- Tissue compartment halftimes (mins.) Spencer's "M" values
5, 10, 20, 40, 80, 120, 160, 200, 240, 320, 400, 480
- Reciprocal subsurface elimination
- 60 minute surface credit control for compartments faster than 60 minutes
- Tissue compartments tracked up to 24 hours after last dive

Decompression Capabilities (stop ceilings):

- 10, 20, 30, 40, 50, and 60 FT
(3, 6, 9, 12, 15, and 18M)

Altitude Algorithm and Oxygen Exposure Limits:

- Based on NOAA tables

TRANSMITTERS

- Battery and Pressure check
 - > every 2 minutes when asleep
 - > every 2 seconds when awake
- Startup
 - > Pressure equal or greater than 120 PSI (8 BAR)
 - > Battery equal or greater than 2.75 volts
- Shutdown
 - > Pressure less than 50 PSI (3.5 BAR)

SURFACE SEQUENCE/MODES

- NORM/GAUG/FREE Surface Mode
- Plan (30 to 190 FT/9 to 57 M) - NORM only
- Time to Fly Countdown - NORM/GAUG
- Time to Desaturation Countdown - NORM only
- Dive Log - NORM/GAUG
- History - NORM/GAUG
- Battery/Tank Pressure Status - NORM/GAUG
- Set FO2, Alarms, Utilities, Time - NORM/GAUG

FREE MODE SETTINGS

- Count Down Timer (0:00 to 59:59 min:sec)
- Elapsed Dive Time Alarm (Off/On) - fixed every 30 sec
- Depth Alarm 1 (30 to 330 FT /10 to 100 M)
- Depth Alarm 2 (40 to 330 FT /11 to 100 M)
- Depth Alarm 3 (50 to 330 FT /12 to 100 M)
- NIBG Alarm - fixed at 7 segments
- DECO Alarm - fixed at 8 NIBG segments

SPECIFICATIONS (CONTINUED)

NORM/GAUG SET MODES

- Set F Group (FO2 items): > Factory Settings:
 - FO2 GAS1 (Air, 21 to 50%) > Air
 - FO2 GAS2 (Air, 21 to 100%) > Air
 - FO2 GAS3 (Air, 21 to 100%) > Air
 - FO2 Default (On/Off) > On

- Set A Group (Alarms):
 - Audible Alarm / LED Warning (On/Off) > On
 - Max Depth Alarm (30 to 330 FT /10 to 100 M) > 330 FT
 - Elapsed Dive Time Alarm (:10 to 3:00 hr:min) > 3:00 (hr:min)
 - Max NIBG Alarm (1 to 7 segments) > 5 segments (Deco)
 - Dive Time Remaining Alarm (:00 to :20 min) > :20 (min)
 - Turn Press Alarm (Off, 1000 to 3000 PSI / 70 to 205 BAR) > Off
 - End Press Alarm (300 to 1500 PSI / 20 to 105 BAR) > 300 PSI
 - Max PO2 Alarm (1.20 to 1.60 ATA) > 1.60 (ATA)

- Set U Group (Utilities):
 - Wet Activation (On/Off) > On
 - Units of Measure (Imperial / Metric) > Imperial
 - Safety Stop Time, Depth (Off/3/5 minutes, 10/15/20 FT, 3/4/5/6 M) > 3:00 (min:sec)
 - Conservative Factor (On/Off) > Off
 - Backlight Duration (0/5/10 seconds) > :05 (sec)
 - Sampling Rate (2/15/30/60 seconds) > 15 (sec)
 - Transmitter 1 Link Code (Off/On, 000000 to 999999) > serial no.
 - Transmitter 2-3 Use (Self/Bud) > Self
 - Transmitter 2 Link Code (Off/On, 000000 to 999999) > serial no.
 - Transmitter 3 Link Code (Off/On, 000000 to 999999) > serial no.

SPECIFICATIONS (CONTINUED)

NORM/GAUG SET MODES (continued)

- Set T Group (Time/Date): Factory Settings:
 - Hour Format (12/24) > 12
 - Time (hour:min) > actual at factory
 - Date (year/month/day) > 0101 2006
- Elite T3 Serial Number
 - Factory set > actual

NORM No Decompression Dive Displays:

- Main (default) - NIBG, O2BG, VARI, Pressure, Dive Time Remaining, Current Depth
- Alternate #1 - Day of Week, Temperature, Time of Day (hr:min)
- Alternate #2 - NIBG, O2BG, VARI, ATR, TMT #, Pressure, Elapsed Dive Time, Air Time Remaining, Max Depth
- Alternate #3 - NIBG, O2BG, VARI, GAS #, Current PO2, FO2 Set Point, Current Depth
- Safety Stop - NIBG, O2BG, VARI, Pressure, Stop Depth, Stop Time, Dive Time Remaining, Current Depth

NORM Decompression Dive Displays:

- Main (default) - NIBG, O2BG, VARI, Stop Depth, Pressure, Stop Time, Total Ascent Time, Current Depth
- Alternate #1 - Day of Week, Temperature, Time of Day (hr:min)
- Alternate #2 - NIBG, O2BG, VARI, ATR, TMT #, Pressure, Elapsed Dive Time, Air Time Remaining, Max Depth
- Alternate #3 - NIBG, O2BG, VARI, GAS #, Current PO2, FO2 Set Point, Current Depth

NORM Violation Modes (displays similar to Deco) - Conditional, Delayed, and Immediate/Violation Gauge

NORM High PO2 (1.20 to 1.60 ATA)

NORM High Oxygen Accumulation (300 OTU per dive / 24 hr)

NORM Gas Switch Preview (TMT 2-3 Use set for Self) - NIBG, O2BG, Gas #, FO2 Set, Current Depth

NORM Buddy Tank Pressure Check (TMT 2-3 Use set for Bud) - BUD #, Pressure

SPECIFICATIONS (CONTINUED)

GAUG Dive Displays:

- Main (default) - graphic GAUG, VARI, Pressure, Current Depth
- Alternate 1 - Day of Week, Temperature, Time of Day (hr:min)
- Alternate 2 - TMT #, VARI, Pressure, Elapsed Dive Time, Air Time Remaining, Max Depth

FREE Dive Displays:

- Main (default) - graphic FREE, Temperature, Elapsed Dive Time (min:sec), Current Depth
- Alternate 1 - Day of Week, Temperature, Time of Day (hr:min)
- CDT Status - graphic TIMR (Timer), Timer Setting (On/Off), Countdown Time Remaining (min:sec)

NUMERIC DISPLAYS:

	<u>Range:</u>	<u>Resolution:</u>
• NORM/GAUG Dive Number	0 to 24	1
• FREE Dive Number	0 to 99	1
• Current Depth	0 to 330/399 FT (100/120 M)	1 FT (.1 M)
• Maximum Depth	330/399 FT (100/120 M)	1 FT (.1 M)
• Gas 1 FO2 Set Point	Air, 21 to 50 %	1 %
• Gas 2 FO2 Set Point	Air, 21 to 100 %	1 %
• Gas 2 FO2 Set Point	Air, 21 to 100 %	1 %
• PO2 Value	0.00 to 5.00 ATA	.01 ATA
• Dive Time Remaining	0:00 to 9:59 hr:min	1 minute
• Air Time Remaining	0:00 to 9:59 hr:min	1 minute
• Total Ascent Time	0:00 to 9:59 hr:min	1 minute
• No Deco Safety Stop Time	5:00 to 0:00 min:sec	1 second
• Decompression Stop Time	0:00 to 9:59 hr:min	1 minute
• NORM/GAUG Elapsed Dive Time	0:00 to 9:59 hr:min	1 minute
• FREE Elapsed Dive Time	0:00 to 59:59 min:sec	1 second
• Surface Interval Time	0:00 to 23:59 hr:min	1 minute
• FREE Surface Interval Time	0:00 to 59:59 min:sec	1 second
	1:00 to 23:59 hr:min	1 minute
• Dive Log Surface Interval	0:00 to 23:59 hr:min	1 minute
• Time to Fly	23:50 to 0:00 hr:min*	1 minute

(* starting 10 min after the dive)

SPECIFICATIONS (CONTINUED)

NUMERIC DISPLAYS (cont'd):

	<u>Range:</u>	<u>Resolution:</u>
• Time to Desaturate	23:50 max to 0:00 hr:min* (* starting 10 min. after the dive)	1 minute
• Temperature	0 to 140°F (-9 to 60°C)	1°
• Tank Pressure	0 to 5000 PSI (345 BAR)	5 PSI (1 BAR)
• Time of Day	0:00:00 to 23:59:59 hr:min	1 minute
• FREE Countdown Timer	59:59 to 0:00 min:sec	1 second
• Out of Range (- - -)	=> 330/399 FT (100/120 M)	
• Violation Countdown Timer	23:50 to 0:00 hr:min (after violation)	

BAR GRAPHS

Nitrogen Loading Bar Graph: segments

- No Decompression zone 1 to 7
- Decompression zone 8 (all)

Oxygen (O2) Bar Graph: segments

- Normal zone 1 to 4
- Danger zone 5 (all)

Variable Ascent Rate Indicator:

Deeper than 60 FT (18 M)

Segments	Ascent Rate =	
	<u>Displayed</u>	<u>FPM</u> <u>MPM</u>
0	0-20	0-6
1	21-30	6.1-9
2	31-40	9.1-12
3	41-50	12.1-15
4	51-60	15.1-18
5	60 +	18 +

60 FT (18 M) & Shallower

Segments	Ascent Rate =	
	<u>Displayed</u>	<u>FPM</u> <u>MPM</u>
0	0-10	0-3
1	11-15	3.1-4.5
2	16-20	4.6-6
3	21-25	6.1-7.5
4	26-30	7.6-9
5	30 +	9 +

SPECIFICATIONS (CONTINUED)

OPERATIONAL PERFORMANCE

Function:

- Depth
- Timers

Accuracy:

- ±1% of full scale
- 1 second per day

Dive Counter:

- NORM/GAUG displays Dives #1 to 24, FREE displays Dives #1 to 99, 0 if no dive made yet
- Resets to Dive #1, upon diving (after 24 hours with no dives)

NORM/GAUG Dive Log Mode:

- Stores 24 most recent NORM/GAUG dives in memory for viewing
- After 24 dives, adds 25th dive in memory and deletes the older dive

Altitude:

- Operational from sea level to 14,000 feet (4,270 meters) elevation
- Measures ambient pressure every 30 minutes when not activated, upon activation by push button, and every 15 minutes while in NORM/GAUG/FREE Surface Modes.
- Does not measure ambient pressure when Wet.
- Compensates for Altitudes above sea level beginning at 2,000 feet (610 meters) elevation and every 1,000 feet (305 meters) higher.

Conservative Factor:

- Reduces NORM NDLS to those for the Altitude 3,000 feet (915 meters) higher.

Power:

- Elite T3 Battery 1 - 3 vdc, CR2450, Lithium battery
- Transmitter Battery 1 - 3 vdc, CR2, .75 Ahr, Lithium battery (Duracell model DL-CR2 or equivalent)
- Shelf life Up to 5 years
- Replacement User replaceable (annual recommended)
- Use Life (Elite T3) 1 year or 300 dive hours if 2 - 1 hour dives per dive day
- Use Life (Transmitter) 300 dive hours if 2 - 1 hour dives per dive day

SPECIFICATIONS (CONTINUED)

OPERATIONAL PERFORMANCE (continued) -

Battery Indicator:

- Warning - icon on solid at 2.75 volts, Elite T3 Battery change recommended
- Alarm - icon on flashing at 2.50 volts, change the Elite T3 Battery

Activation:

- Manual - push button (recommended), required if Wet Activation is set OFF.
- Automatic - by immersion in water (if set ON)
- Graphic WET indicates Activation Contacts are Wet (unit must be dried prior to transport or storage)
- Cannot be manually activated deeper than 4 FT (1.2 M), if Water Activation is set OFF.
- Cannot operate at elevations higher than 14,000 feet (4,270 meters)

Operating Temperature:

- Out of the water - between 20 °F and 140 °F (-6 and 60 °C).
- In the water - between 28 °F and 95 °F (-2 and 35 °C).
- At extremely low temperatures, the LCD may become sluggish, but this will not affect it's accuracy. If stored or transported in extremely low temperature areas (below freezing), you should warm the unit and its battery with body heat before diving.

Storage Temperature:

- Out of the water - between 14 °F and 158 °F (-8 and 70 °C).

INSPECTION / SERVICE RECORD

Elite T3 Serial Number: _____

Transmitter #1 Serial Number: _____

Transmitter #2 Serial Number: _____

Transmitter #3 Serial Number: _____

Date of Purchase: _____ Purchased from: _____

Below to be filled in by an Authorized AERIS Dealer:

Date	Service Performed	Dealer / Technician

AERIS

**2002 Davis Street
San Leandro, CA 94577**

Tel: 510/346-0010

Fax: 510/346-0015

Web site: <http://www.diveaeris.com>

E-mail: info2@diveaeris.com